



Processing: 08/05/2026

SCHEDA TECNICA PRODOTTO

DATASHEET

ARTICOLO: LED SAETTA 32W 3000K 40°

CODICE: SAE32403K

Caratteristiche meccaniche/Mechanical features:

Corpo / Body:	Estruso in alluminio anodizzato Extruded anodized aluminium
Cornice / Frame:	Cromo satinato / Satin Chrome
Colore / Colour:	Grigio / Grey
Diffusore / Diffuser:	Vetro trasparente temprato Tempered transparent glass
Dissipazione / Dissipation:	Statica/Static
Viteria / Screws:	Acciaio/Steel
Peso / Weight:	6,5Kg
Carrabilità / Driver over:	Calpestabile e carrabile, fino a 10Km/h - 1000Kg con pneumatici gonfiati ad aria. Non sostare. Walkable and drive-over, up to 10Km/h - 1000Kg with air-inflated tires. Don't stop.

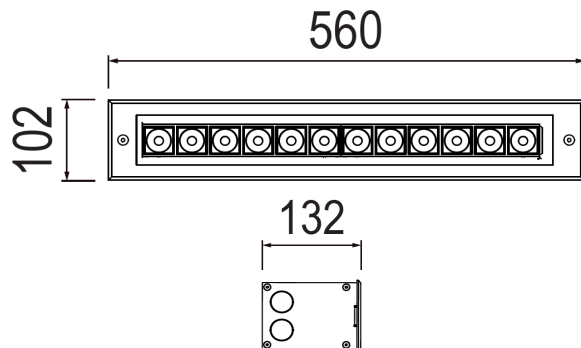

Caratteristiche elettriche/Electrical features:

Alimentazione / Power supply:	24Vdc
Potenza / Power:	32W
Alimentatore / Driver:	NON Incluso / NOT Included
Aspettativa di vita / Life expectation:	50.000h L80/B10
Indice Mac Adam / Mac Adam index:	3
Rischio fotobiologico / Photobiological risk:	RGO

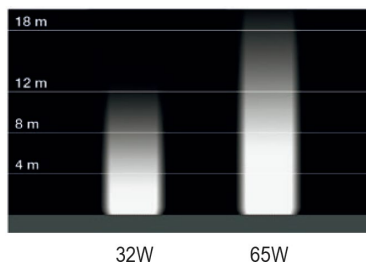

Caratteristiche illuminotecniche/Photometric features:

Tipo di LED/LED type:	LED SMD
*Flusso luminoso/Luminous flux:	2880lm
CCT:	3000K
Lm/W:	90 lm/W
CRI:	>80
Ottica secondaria/Secondary optic:	40°

*I dati hanno una tolleranza ± 10% - data have a tolerance ± 10%

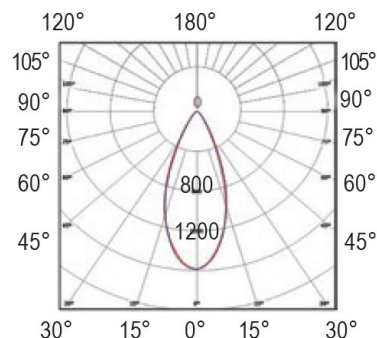
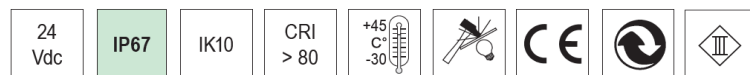

Conforme alle seguenti norme/Complying with the following standards:

Sicurezza/Safety:	Generale/General:	EN-60598-1
	Particolari/Particular:	EN-60598-2-2
	Moduli LED/LED Modules:	EN-62031+A1
Sicurezza fotobiologica/Photobiological safety:		EN 62471 (Risk exempt)
Esposizione umana ai campi elettromagnetici/Human exposure to electromagnetic fields:		EN-62493
Immunità EMC/EMC immunity:		EN-61547
Compatibilità elettromagnetica/Electromagnetic compatibility:		EN-61000-3-3
Limiti di emissioni armoniche/Limits of harmonic emissions:		EN-61000-3-2



RELCO group persegue una politica di continua ricerca e sviluppo, quindi si riserva di variare in qualsiasi momento e senza preavviso le caratteristiche dei prodotti.

RELCO group pursues a policy of continuous research and development and reserves the right to change at any time and without prior notice, the characteristics of the products