

SCHEDA TECNICA PRODOTTO

DATASHEET

ARTICOLO: LED MILANO SPORT 1 400W 40° 6K

CODICE: MI-400-40-6K



Caratteristiche meccaniche/Mechanical features:

Corpo e telaio / Housing and frame :	Alluminio pressofuso / Die-cast aluminium
Staffa di fissaggio / Fitting stirrup :	Acciaio zincato a caldo / Hot galvanised steel
Colore/Colour:	Grigio RAL 9007 / RAL 9007 grey
Lenti/Lenses:	Policarbonato metallizzato / Metallized polycarbonate
Schermo/Shield:	Vetro temperato ultra white / Ultra white Tempered glass
Viteria/Screws:	INOX AISI 304
Dissipazione/Dissipation:	Statica/Static
Peso/Weight:	11 Kg

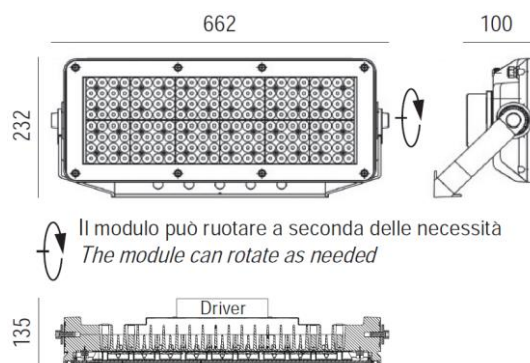

IP66 IK08



Caratteristiche elettriche/Electrical features:

Alimentazione/Power supply:	100-240V AC 50/60Hz
Potenza/Power:	400W
Fattore di potenza/Power factor:	>0,9
Corrente di spunto/Inrush current:	25A 400µS
Efficienza/Efficiency:	92%
Filtro antidisturbi/Noise filter:	EN 55015
Alimentatore/Driver:	Incluso/Included
Protezione sovratensione/Surge protection:	5KV Differential Mode 10KV Common Mode



Caratteristiche illuminotecniche/Photometric features:

Tipo di LED/LED type:	n° 120 LED SMD 5050
*Flusso luminoso/Luminous flux:	58.000 lm
*Lm/W:	145 lm/W
CCT:	5700K
CRI:	80
Ottica secondaria/Secondary optic:	40°
Aspettativa di vita/Life expectation:	80.000h L80/B20
Indice Mac Adam/Mac Adam index:	3
Rischio fotobiologico/Photobiological risk:	RG0

*i dati hanno una tolleranza ± 10% - data have a tolerance ± 10%

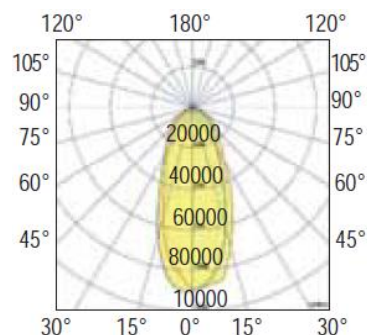

Conforme alle seguenti norme/Complying with the following standards:

Sicurezza/Safety:	Generale/General:	EN-60598-1
	Particolari/Particular:	EN-60598-2-1
	Moduli LED/LED Modules:	EN-62031+A1
Sicurezza fotobiologica/Photobiological safety:		EN 62471 (Risk exempt)
Esposizione umana ai campi elettromagnetici/Human exposure to electromagnetic fields:		EN-62493
Immunità EMC/EMC immunity:		EN-61547
Compatibilità elettromagnetica/Electromagnetic compatibility:		EN-61000-3-3
Limiti di emissioni armoniche/Limits of harmonic emissions:		EN-61000-3-2



RELCO group persegue una politica di continua ricerca e sviluppo, quindi si riserva di variare in qualsiasi momento e senza preavviso le caratteristiche dei prodotti.

RELCO group pursues a policy of continuous research and development and reserves the right to change at any time and without prior notice, the characteristics of the products