

# LED Primadonna Trifase



Serie di proiettori orientabili progettati per illuminare spazi commerciali (supermercati, grandi magazzini, retail, ecc.), uffici e qualsiasi ambiente dove è necessaria un'illuminazione generale e d'accento.

Ora disponibile la nuova serie "LED Primadonna Meat & vegetables" mirata a risaltare la qualità e la freschezza dei prodotti alimentari e incentivarne l'acquisto con maggiori vantaggi di costi di gestione e maggior durata dei prodotti alimentari differenti quali carni, insaccati, frutta, verdura. Tonalità di luce ottimizzate al fine di valorizzare ciascun tipo di alimento nel food lighting.

L'utilizzo della tecnologia LED garantisce una resa illuminotecnica elevata in relazione al consumo di energia, annullando i costi di manutenzione con un notevole risparmio economico.

**Installazione:** su binario trifase Eurostandard (completo di adattatore)

**Corpo:** in alluminio pressofuso UNI 5076, verniciato con polvere termoindurente poliestere. Colore Nero o Bianco RAL 9010.

**Orientabilità:** Z=350°, Y=90°

**Viteria:** in acciaio

**Verniciatura:** di tipo poliestere eseguita a polvere

**Ottica:** concentrante e semi concentrante

**Schermo:** vetro temperato di spessore 3mm

**Temperatura di colore:** 3000K e 4000K; altre temperature di colore a richiesta

**Conforme alla norma:** EN60598-1, RG0 nessun rischio fotobiologico ai fini della norma EN62471.

**Led:** CREE manutenzione del flusso luminoso minimo al 80%: 50.000h (L80B10).

**Driver:** incluso  Fattore di potenza ≥0,95.

*A series of direction-adjustable flood lights designed for lighting in shopping malls (supermarkets, department stores, retail stores, etc.), offices and any facility requiring general and accent lighting.*

*The new "LED Primadonna Meat & vegetables" series is now available, aimed at bringing out the quality and freshness of food products and entice people to purchase them with greater advantages in terms of management costs and longer duration of different food products such as meat, cold cuts, fruit and vegetables. Shades of light optimised to enhance each type of food through food lighting.*

*The use of LED technology guarantees high lighting engineering output in relation to energy consumption, eliminating maintenance costs and thereby offering considerable economic savings.*

**Installation:** on three-phase Eurostandard tracks (complete with adapter)

**Body:** made by UNI 5076 die-cast aluminum, coated with polyester thermoset powder.

**Adjustability:** Z=350°, Y=90°.

**Screws:** made by steel.

**Coating:** coated with powdered polyester. Black or RAL 9010 White color.

**Optic:** semi-clumping.

**Optic:** clumping and semi-clumping.

**Shield:** tempered glass with 3mm thickness.

**Color temperature:** 3000K and 4000K; other color temperatures available on demand.

**According to standard:** EN60598-1, RG0 exempt from photobiological risks in compliance with standard EN62471.

**Led:** CREE maintenance of minimum luminous flux to 80%: 50.000h (L80B10).

**Driver:** included  Power factor ≥0,95.



A richiesta  
On demand

0-10V



WIRELESS

220-240V 50/60Hz



IK07

IP20

LED Primadonna



LED Primadonna 20W

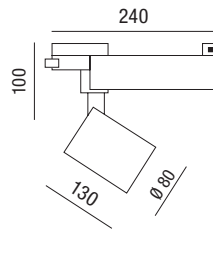

LED Primadonna 30W

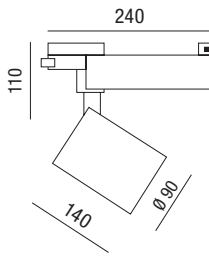

LED Primadonna 40W

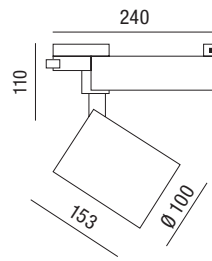

LED Primadonna 60W

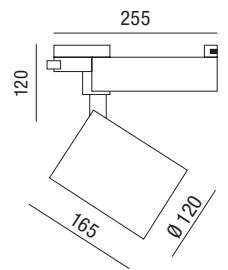

| colour        | W  |         | lm output | K    |      | pcs | Kg   | CELL        |
|---------------|----|---------|-----------|------|------|-----|------|-------------|
| B             | 20 | Led COB | 2000      | 3000 | 40°  | 001 | 1,20 | 32920/20    |
| B             | 20 | Led COB | 2000      | 4000 | 40°  | 001 | 1,20 | 32920/20/4K |
| B             | 20 | Led COB | 2000      | 3000 | 24°  | 001 | 1,20 | 32921/20    |
| N             | 20 | Led COB | 2000      | 3000 | 40°  | 001 | 1,20 | 32922/20    |
| N             | 20 | Led COB | 2000      | 4000 | 40°  | 001 | 1,20 | 32922/20/4k |
| N             | 20 | Led COB | 2000      | 3000 | 24°  | 001 | 1,20 | 32923/20    |
| <b>U-BOOT</b> | B  | 30      | Led COB   | 3000 | 3000 | 40° | 001  | 3292030UB   |
| <b>U-BOOT</b> | B  | 30      | Led COB   | 3000 | 4000 | 40° | 001  | 32920304KUB |
| B             | 30 | Led COB | 3000      | 3000 | 24°  | 001 | 1,30 | 32921/30    |
| <b>U-BOOT</b> | B  | 30      | Led COB   | 3000 | 3000 | 24° | 001  | 32921/30/UB |
| N             | 30 | Led COB | 3000      | 3000 | 40°  | 001 | 1,30 | 32922/30    |
| <b>U-BOOT</b> | N  | 30      | Led COB   | 3000 | 3000 | 40° | 001  | 32922/30/UB |
| <b>U-BOOT</b> | N  | 30      | Led COB   | 3000 | 4000 | 40° | 001  | 32922304KUB |
| N             | 30 | Led COB | 3000      | 3000 | 24°  | 001 | 1,30 | 32923/30    |
| B             | 40 | Led COB | 4000      | 3000 | 40°  | 001 | 1,40 | 32920/40    |
| B             | 40 | Led COB | 4000      | 4000 | 40°  | 001 | 1,40 | 32920/40/4K |
| N             | 40 | Led COB | 4000      | 3000 | 40°  | 001 | 1,40 | 32922/40    |
| N             | 40 | Led COB | 4000      | 4000 | 40°  | 001 | 1,40 | 32922/40/4K |
| N             | 40 | Led COB | 4000      | 3000 | 24°  | 001 | 1,40 | 32923/40    |
| B             | 60 | Led COB | 6000      | 3000 | 40°  | 001 | 1,55 | 32920/60    |
| B             | 60 | Led COB | 6000      | 4000 | 40°  | 001 | 1,55 | 32920/60/4K |
| B             | 60 | Led COB | 6000      | 3000 | 24°  | 001 | 1,55 | 32921/60    |
| B             | 60 | Led COB | 6000      | 4000 | 24°  | 001 | 1,55 | 32921/60/4K |
| N             | 60 | Led COB | 6000      | 3000 | 40°  | 001 | 1,55 | 32922/60    |
| N             | 60 | Led COB | 6000      | 4000 | 40°  | 001 | 1,55 | 32922/60/4K |
| N             | 60 | Led COB | 6000      | 3000 | 24°  | 001 | 1,55 | 32923/60    |

LED Primadonna - 24°

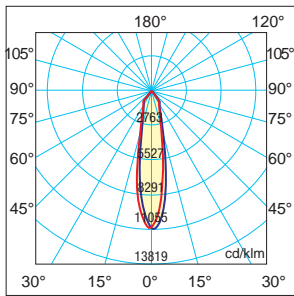

LED Primadonna - 40°

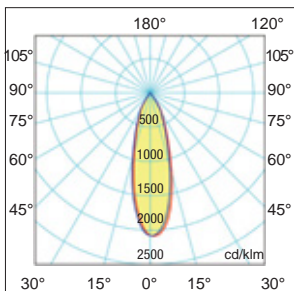

# Illuminazione speciale "Retail Meat & Vegetables"

## Special lighting "Retail Meat & Vegetables"



Centri commerciali, supermercati e negozi di alimenti attuano da sempre politiche volte alla corretta illuminazione, rientra nelle pratiche di promozione prodotti e mai come ora svolge un ruolo primario.

Relco ha studiato una nuova serie di proiettori a LED, Meat & vegetables mirata a risaltare la qualità e la freschezza dei prodotti alimentari e incentivarne l'acquisto con maggiori vantaggi di costi di gestione e maggior durata dei prodotti alimentari differenti quali carni, insaccati, frutta, verdura. Tonalità di luce ottimizzate al fine di valorizzare ciascun tipo di alimento nel food lighting.

Shopping malls, supermarkets and grocery stores have always implemented policies on correct lighting, as this falls within the practice of product promotion and has never played such a primary role as it does now.

Relco has developed a new series of LED flood lights, Meat & vegetables, aimed at bringing out the quality and freshness of food products and enticing people to purchase them with greater advantages of management costs and longer duration of different food products such as meat, cold cuts, fruit and vegetables. Shades of light optimised to enhance each type of food through food lighting.

220-240V 50/60Hz



**IK07** **IP20**



A RICHIESTA  
ON DEMAND

### LED Primadonna Meat & Vegetables

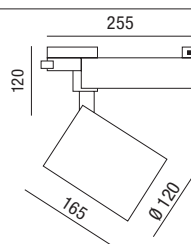

| colour   | W  |         | lm output | K       |     | pcs | Kg   | CELL           |
|----------|----|---------|-----------|---------|-----|-----|------|----------------|
| <b>B</b> | 30 | Led COB | 3000      | SPECIAL | 40° | 001 | 1,20 | 32920/30/FRUIT |
| <b>B</b> | 30 | Led COB | 3000      | SPECIAL | 40° | 001 | 1,20 | 32920/30/MEAT  |
| <b>B</b> | 40 | Led COB | 4000      | SPECIAL | 40° | 001 | 1,30 | 32920/40/FRUIT |
| <b>B</b> | 40 | Led COB | 4000      | SPECIAL | 40° | 001 | 1,30 | 32920/40/MEAT  |
| <b>N</b> | 30 | Led COB | 3000      | SPECIAL | 40° | 001 | 1,20 | 32922/30/FRUIT |
| <b>N</b> | 30 | Led COB | 3000      | SPECIAL | 40° | 001 | 1,20 | 32922/30/MEAT  |
| <b>N</b> | 40 | Led COB | 4000      | SPECIAL | 40° | 001 | 1,30 | 32922/40/FRUIT |
| <b>N</b> | 40 | Led COB | 4000      | SPECIAL | 40° | 001 | 1,30 | 32922/40/MEAT  |

**NEW**

## Driver a scomparsa U-BOOT *hidden U-BOOT driver*



A richiesta i modelli Primadonna da 20W e 30W sono disponibili con driver a scomparsa **U-BOOT** con maggiorazione di 20,00 euro. Aggiungere **U** dopo il codice (es: 32920/30 **U**). Driver a scomparsa **U-BOOT DALI** con maggiorazione di 50,00 euro. Aggiungere **UD** dopo il codice (es: 32920/30 **UD**).

*On request, the Primadonna 20W and 30W models are available with **U-BOOT** retractable driver with an extra charge of 20.00 euros.*

*Add **U** after the code (e.g.: 32920/30 **U**).*

*Retractable driver **U-BOOT DALI** with an extra charge of 50.00 euros.*

*Add **UD** after the code (e.g.: 32920/30 **UD**).*

**NEW**

## Bandiere paraluce *Banner*

| Colour   | Kg    | Code     |
|----------|-------|----------|
| <b>N</b> | 0,250 | 32920/BP |

Bandiere paraluce per versione nera da 40W.  
*40W Lens hood flaps for black version.*

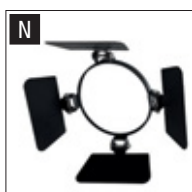

**NEW**

## Filtri *Filters*

| Colour   | Code      |
|----------|-----------|
| <b>N</b> | 32920/SC1 |

Frangiluce nido d'ape per versione da 30W.  
*Honeycomb louvre for 30W version.*

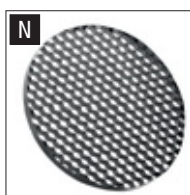

| Colour   | Code      |
|----------|-----------|
| <b>B</b> | 32920/SC2 |

Filtro diffondente opale solo per versione da 40W  
*Opal filter diffuser for 40W version only*

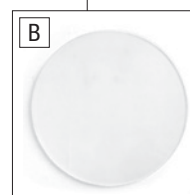

## Orientabilità - *Adjustability*





# MyWay

## LED Primadonna Sistemi di controllo Bluetooth Control systems Bluetooth LED Primadonna

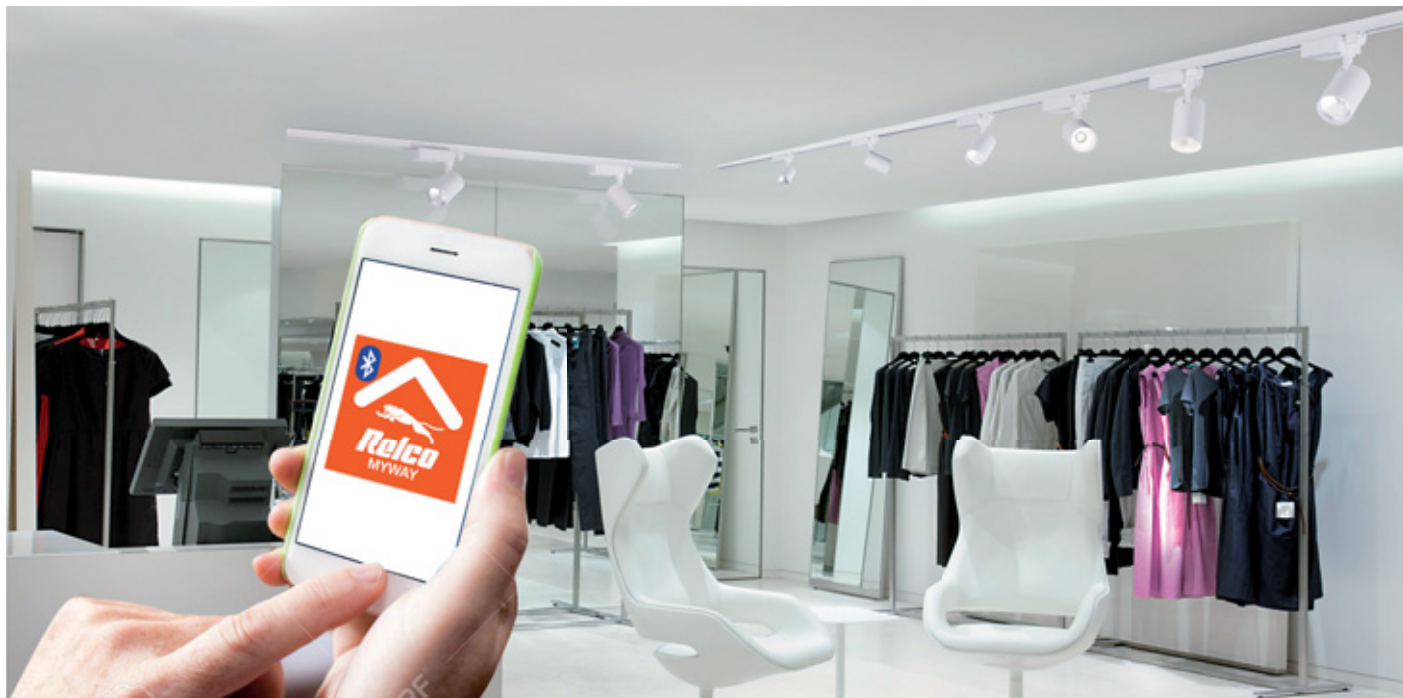

Adattatore da binario con LED driver BLUETOOTH incorporato, max 30W  
Track adapter with built-in BLUETOOTH LED driver, 30W max.

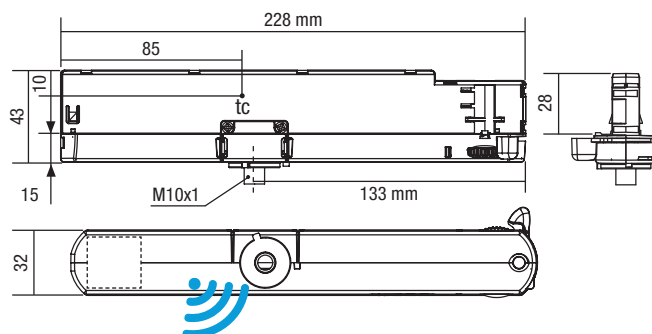

|  | colour | W  |         | lm output | K    |     | pcs | Kg   | CELL        |
|--|--------|----|---------|-----------|------|-----|-----|------|-------------|
|  | B      | 30 | Led COB | 3000      | 3000 | 40° | 001 | 1,30 | 3292030BT   |
|  | N      | 30 | Led COB | 3000      | 3000 | 40° | 001 | 1,30 | 32922/30/BT |

### Modalità di funzionamento

- Regolazione della luminosità 0/1 - 100 % mediante APP o dispositivi compatibili per modulo Myway integrato.
- Caratteristiche della regolazione mediante APP:
  - accensione e spegnimento;
  - creazione e controllo di gruppi;
  - scelta tra scenari preconfigurati;
  - creazione di scenari.

### Operation Mode

- Light regulation 0/1 - 100 % by means of APP or compatible devices for Myway integrated module.
- Features of remote control by APP:
  - turn on and turn off;
  - setup and control of groups;
  - choice among pre-set scenarios;
  - creation of scenarios.

**Tensione Nominale**  
**Rated Voltage**  
220 ÷ 240 V

**Corrente Nominale**  
**Rated Current**  
0,20 A

**Corrente di Spunto**  
**Inrush Current**  
5 A - 50 µS

**Potenza Uscita**  
**Output Power**  
6,5 ÷ 31 W

**Standards compliance**  
EN 55015  
EN 61000-3-2  
EN 61347-1  
EN 61347-2-11  
EN 61547  
EN 62311  
ETSI EN 300 328  
ETSI EN 301 489-1 ETSI EN 301 489-17



### App proprietaria Proprietary app

Utilizzabile scaricando l'APP disponibile su Apple Store e Play Store per sistemi iOS e Android.  
It can be used by downloading the APP available on the Apple Store and Play Store for iOS and Android systems.