

LED Otto

Apparecchi da incasso progettati per illuminare aree comuni, corridoi, laboratori, sale riunioni, uffici e qualsiasi ambiente dove è necessaria un'illuminazione diffusa. La struttura del faretto è a base tonda o quadrata, ideale per sostituire apparecchi con sorgenti fluorescenti compatte.

Installazione: ad incasso in controsoffitti di cartongesso (completo di staffe di fissaggio)

Corpo e telaio LED Otto Q1 - Q3 - T2: in alluminio pressofuso UNI 5076, verniciato con polvere termoindurente poliestere

Corpo e telaio LED Otto T3 - T4 - T5: in tecnopolimero ad alta resistenza

Staffe di fissaggio: in acciaio

Viteria: in acciaio

Verniciatura: di tipo poliestere eseguita a polvere. Colore bianco RAL 9010

Ottica: diffondente

Schermo: in lastra tecnopolimero opale

Temperatura di colore: 3000K - 4000K.

Driver: incluso

Conforme alla norma: EN60598-1, RG0 nessun rischio fotobiologico ai fini della norma EN62471.

Recessed downlights designed to light up common areas, corridors, laboratories, meeting rooms, offices and any other place that requires diffused lighting. The luminaire structure is round or square, ideal to replace fixtures with compact fluorescent lamps.

***Installation:** recessed use in plasterboard false ceilings (complete with fixing brackets)*

***LED Otto Q1 - Q3 - T2 body and frame:** made by UNI 5076 die-cast aluminum, coated with polyester thermoset powder*

***LED Otto T3 - T4 - T5 body and frame:** made by engineering polymer with high resistance*

***Fixing brackets:** made by steel*

***Screws:** made by steel*

***Coating:** coated with powdered polyester. RAL 9010 white color*

***Optic:** diffused*

***Shield:** opal engineering polymer sheet*

***Color temperature:** 3000K - 4000K.*

***Driver:** included*

***According to standard:** EN60598-1, RG0 exempt from photo-biological risks in compliance with standard EN62471.*



LED Otto Q1

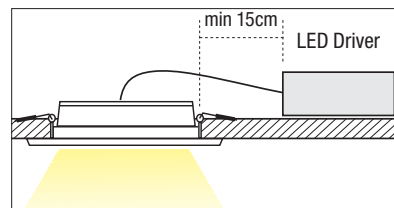
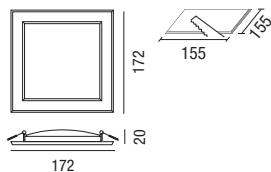

colour	W		lm output	K	pcs	Kg	CELL
B	12	Led SMD	1.080	3000	001	0,30	25918/3000

LED Otto T5

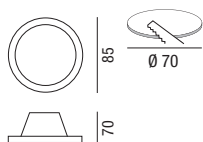

LED Otto T3 - T4 - T5
Driver interno - Driver inside.

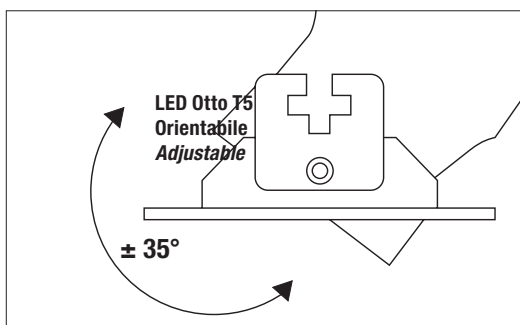

colour	W		lm output	K	pcs	Kg	CELL
B	9	Led SMD	900	4000	001	0,20	24922
B	9	Led SMD	900	3000	001	0,20	24922/3000

LED Otto T3 - T4

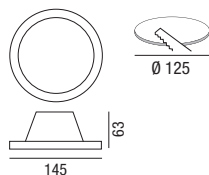

LED Otto T3

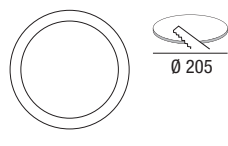

LED Otto T4

LED Otto T4 ACCESSORIO PER PLAFONE NON INCLUSO
LED Otto T4 CEILING ACCESSORY NOT INCLUDED

Cod. 25924/PL

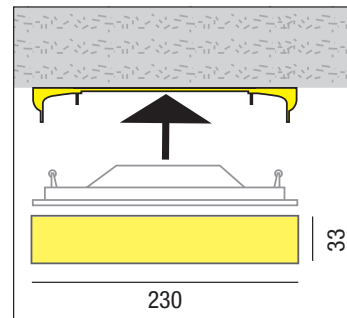

3in1



colour	T.	W		lm output	K	pcs	Kg	CELL		
B	T3	12	Led SMD	1200	3000	4000	6000	001	0,30	25923/3-4-6K
B	T4	25	Led SMD	2500	3000	4000	6000	001	0,40	25924/3-4-6K