

Aura S
suspension up & down
Pag. 512

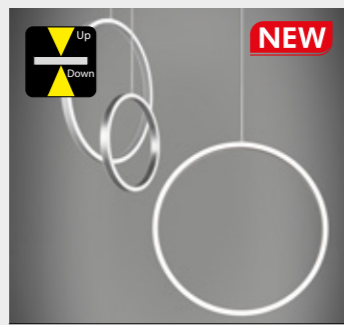

Aura S verticale, multi Aura
suspension up & down
Pag. 520



Aura W
wall up & down
Pag. 526



Aura track verticale
track up & down
Pag. 528



Pendel
suspension
Pag. 530



Zero - Mario
suspension
Pag. 531

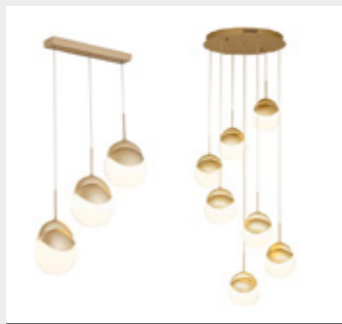

Geranio 3S - Geranio 7S
suspension
Pag. 532

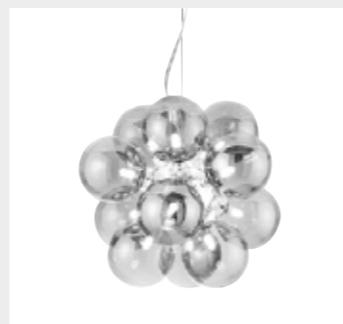

Glicine S
suspension
Pag. 533



Agave C - Diphylleia S
suspension
Pag. 534



Orchidea S
suspension
Pag. 534



Ibisco S - Lilla S - Calla S
suspension
Pag. 535



Gerbera S - Lavanda S
suspension
Pag. 536



Hemisphere S
suspension
Pag. 536



Girasole
ceiling, Wall, Floor, Table
Pag. 538



Lisianthus -Anthurium
wall
Pag. 541



FLEX applique Black
wall
Pag. 541



Giacinto - Ego - Baby
wall, ceiling
Pag. 542



Jodie S
suspension
Pag. 543

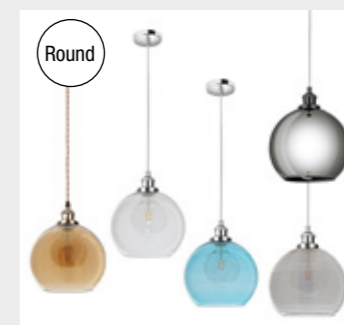

Vetro Palla S
suspension
Pag. 546



Vittoria, Fatua
table
Pag. 547



Jeri S
suspension
Pag. 548



Aki - Cupo - Font - Milu
wall
Pag. 550



Ariete quadro
wall, ceiling
Pag. 551



Ariete tondo
wall, ceiling
Pag. 552



Sovraspecchio
wall
Pag. 554



Specchio serie
wall
Pag. 556



Gerbera F - Nandina F
floor
Pag. 556

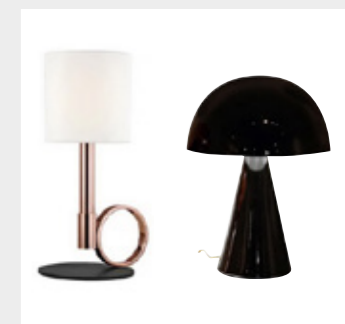

Buddleja T - Lavanda T
floor - table
Pag. 556



Smart
floor, table
Pag. 557



LED Po, LED Tevere lanterna
table
Pag. 558



LED Reno, LED Piave
floor, table
Pag. 559

Aura

Design: Giancarlo Tintori



Cerchi luminosi dalle linee essenziali a doppia emissione a sviluppo orizzontale declinati in versione verticale e a cascata grazie ai rosoni studiati per alimentare multilampade, il tutto abbinabile ad una elegante versione a parete disponibile in due misure.

Estremamente versatile può esistere in sospensioni singole o in composizioni a varie altezze a creare effetti scenografici.

Ideali per ambienti residenziali, uffici e spazi pubblici, realizzati con anelli in alluminio equipaggiati con LED SMD integrati, compatibili con interruttore dimmer e cavi regolabili in altezza.

Emissione: diretta, indiretta o entrambe le emissioni.

Diffusori in gomma ai siliconi; ottica diffondente opale ad alta trasmittanza.

Cri: 90

Colore: 4 colori disponibili bianco lucido RAL 9010, nero opaco RAL 9005, grigio RAL9006, oro satinato, Bronzo RAL8028.

Comando: con normale interruttore ON-OFF (2 fili + terra).
DIM DALI 2 PUSH (4 fili + terra) .

Temperatura di colore: colorazione standard bianco 3000K a richiesta bianco caldo 2700K e bianco neutro 4000K.

Ugr: UGR ≤17.

Luminous circles with essential lines with double emission and horizontal development available in vertical and cascade versions thanks to the rosettes designed to power multiple lamps, all combined with an elegant wall version in two sizes.

Extremely versatile, it can exist in single suspensions or in compositions at various heights to create scenographic effects.

Ideal for residential environments, offices and public spaces, made with aluminum rings equipped with integrated SMD LEDs, compatible with dimmer switch and height-adjustable cables.

Emission: direct, indirect or both emissions.

Silicone rubber diffusers; opal diffusing optic with high transmittance.

Cri: 90

Colour: 5 colours available: Polished white RAL 9010, opal black RAL 9005, grey RAL9006, satin gold, Bronze RAL8028.

Control: with normal ON-OFF switch (2 wires + earth).
DIM DALI 2 PUSH (4 wires + earth).

Colour temperature: standard color white 3000K on request warm white 2700K and neutral white 4000K.

Ugr: UGR ≤17.



Versioni Bluetooth a richiesta
Bluetooth version on request

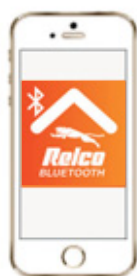

APP
proprietaria Relco.
Relco proprietary APP.



DIMBTDA
Varialuce/Dimmer
Bluetooth DALI 2

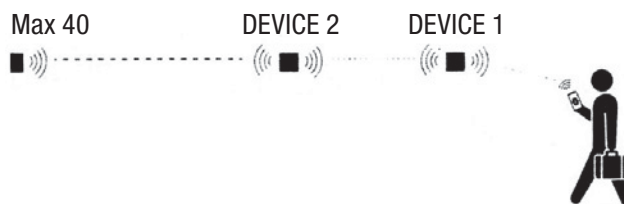

Ecosistema Bluetooth DALI2 in grado di controllare fino a 40 driver DALI.

Con rete wireless Bluetooth mesh 5.0 rende la comunicazione tra apparecchi molto più semplice senza un lungo cablaggio, che alla fine consente di risparmiare sui costi progetti (specialmente per progetti di aggiornamento retrofit).

La configurazione e la messa in servizio del dispositivo possono essere eseguite tramite app proprietaria Relco.

Ecosystem Bluetooth DALI2 is able to control up to 40 LED drivers.

The Bluetooth mesh 5.0 wireless network greatly simplifies communication between the devices without long wires, ultimately saving on design costs (especially for retrofit update projects).

The device can be configured and put into service using the Relco proprietary app.



Aura S LED 1 anello Up & Down

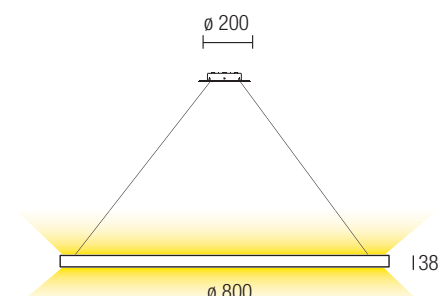
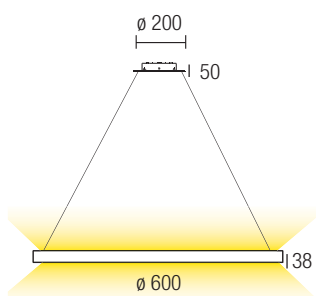
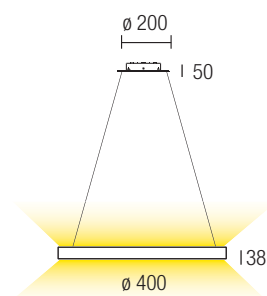

AURA S 40 Up & Down

ON - OFF

DALI 2 PUSH

	762001-3KB	762001-3KBDA
	762001-3KN	762001-3KNDA
	762001-3KG	762001-3KGD
	762001-3KO	762001-3KODA
	762001-3KBR	762001-3KBRDA

Sorgente
Source

Potenza
Total power 2x20W

Temperatura di colore
Color temperature **3000K**
2700K-4000K
ON DEMAND

Flusso luminoso max.
Lighting output max. 2x1000Lm
(50lm/W)

Peso kg
weight kg 1,5

Lunghezza cavi L. max
Cable length L. max 2200mm

220-240V 50/60Hz DRIVER INCLUDED

AURA S 60 Up & Down

ON - OFF

DALI 2 PUSH

	772001-3KB	772001-3KBDA
	772001-3KN	772001-3KNDA
	772001-3KG	772001-3KGD
	772001-3KO	772001-3KODA
	772001-3KBR	772001-3KBRDA

Sorgente
Source

Potenza
Total power 2x30W

Temperatura di colore
Color temperature **3000K**
2700K-4000K
ON DEMAND

Flusso luminoso max.
Lighting output max. 2x1500Lm
(50lm/W)

Peso kg
weight kg 2,25

Lunghezza cavi L. max
Cable length L. max 2200mm

220-240V 50/60Hz DRIVER INCLUDED

AURA S 80 Up & Down

ON - OFF

DALI 2 PUSH

	772002-3KB	772002-3KBDA
	772002-3KN	772002-3KNDA
	772002-3KG	772002-3KGD
	772002-3KO	772002-3KODA
	772002-3KBR	772002-3KBRDA

Sorgente
Source

Potenza
Total power 2x30W

Temperatura di colore
Color temperature **3000K**
2700K-4000K
ON DEMAND

Flusso luminoso max.
Lighting output max. 2x1500Lm
(50lm/W)

Peso kg
weight kg 3,0

Lunghezza cavi L. max
Cable length L. max 2200mm

220-240V 50/60Hz DRIVER INCLUDED

Aura S LED 1 anello Up & Down

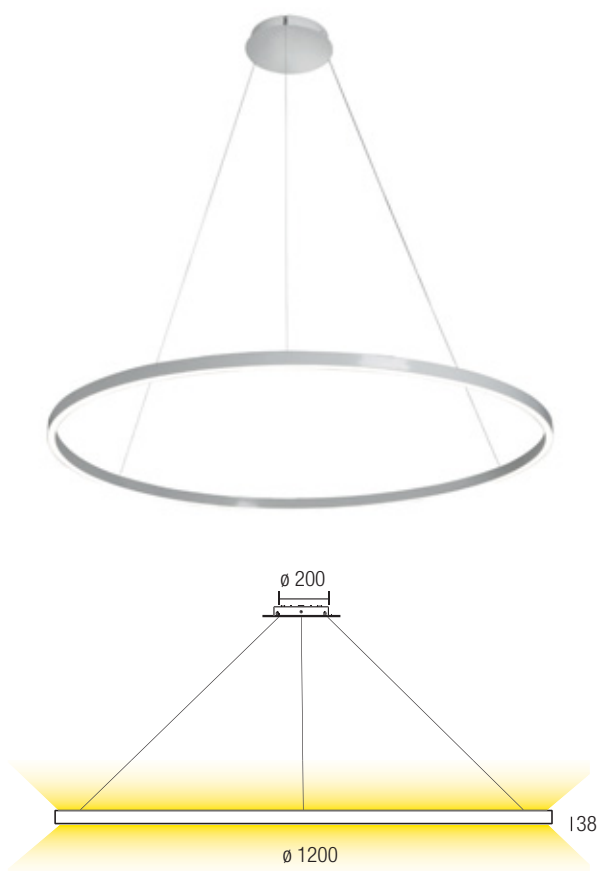

AURA S 120 Up & Down

ON -OFF

DALI 2 PUSH

	772003-3KB	772003-3KBDA
	772003-3KN	772003-3KNDA
	772003-3KG	772003-3KGBDA
	772003-3KO	772003-3KODA
	772003-3KBR	772003-3KBRDA

Sorgente
Source

LED

Potenza
Total power

2x40W

Temperatura di colore
Color temperature

3000K

2700K-4000K
ON DEMAND

Flusso luminoso max.
Lighting output max.

2x2000Lm
(50lm/W)

Peso kg
weight kg

3,75

Lunghezza cavi L. max
Cable length L. max

2200mm

   CELL

220-240V 50/60Hz DRIVER INCLUDED

Aura Ø800, Ø1200 con possibilità di accensioni separate.

Nuove versioni biemissione più performanti complete di driver e moduli LED ad alta efficienza, possono utilizzare accensioni separate per emissione indiretta verso l'alto, diretta verso il basso oppure in entrambe le direzioni. La sorgente luminosa è posizionata in modo da ottenere una luce discreta ed efficace senza la percezione dell'abbagliamento.

Aura Ø800, Ø1200 with the possibility of separate ignitions.

New, more performing dual-emission versions complete with high-efficiency LED drivers and modules can use separate switching for indirect emission upwards, direct downwards or in both directions. The light source is positioned so as to obtain a discreet and effective light without the perception of glare.

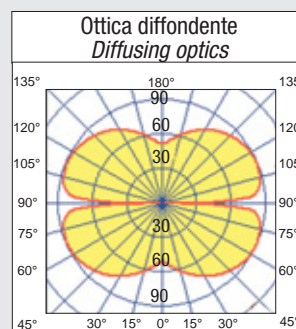
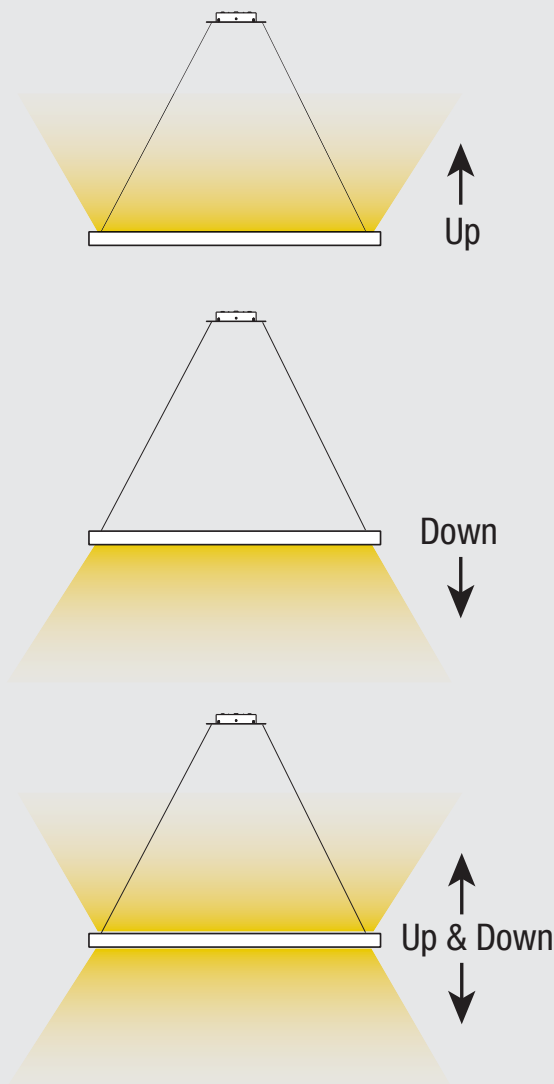





Aura S LED 2, 3 anelli

Up & Down

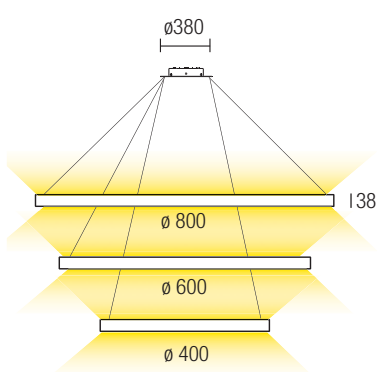
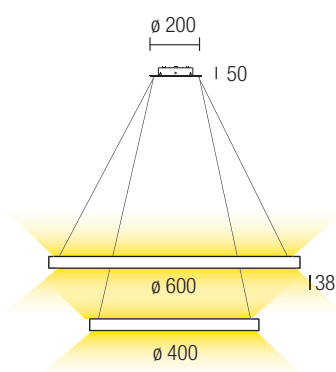

AURA S 40-60 Up & Down

ON -OFF

DALI 2 PUSH

	782002-3KB	782002-3KBDA
	782001-3KN	782001-3KNDA
	782001-3KG	782001-3KGDA
	782001-3KO	782001-3KODA
	782001-3KBR	782001-3KBRDA

Sorgente
Source



Potenza
Total power 2x50W

Temperatura di colore
Color temperature **3000K**

2700K-4000K
ON DEMAND

Flusso luminoso max.
Lighting output max. 2x2500Lm
(50lm/W)

Peso kg
weight kg 3,75

Lunghezza cavi L. max
Cable length L. max 2200mm



220-240V 50/60Hz DRIVER INCLUDED

AURA S 40-60-80 Up & Down

ON -OFF

DALI 2 PUSH

	802002-3KB	802002-3KBDA
	802001-3KN	802001-3KNDA
	802001-3KG	802001-3KGDA
	802001-3KO	802001-3KODA
	802001-3KBR	802001-3KBRDA

Sorgente
Source



Potenza
Total power 2x80W

Temperatura di colore
Color temperature **3000K**

2700K-4000K
ON DEMAND

Flusso luminoso max.
Lighting output max. 2x4000Lm
(50lm/W)

Peso kg
weight kg 6,75

Lunghezza cavi L. max
Cable length L. max 2200mm



220-240V 50/60Hz DRIVER INCLUDED





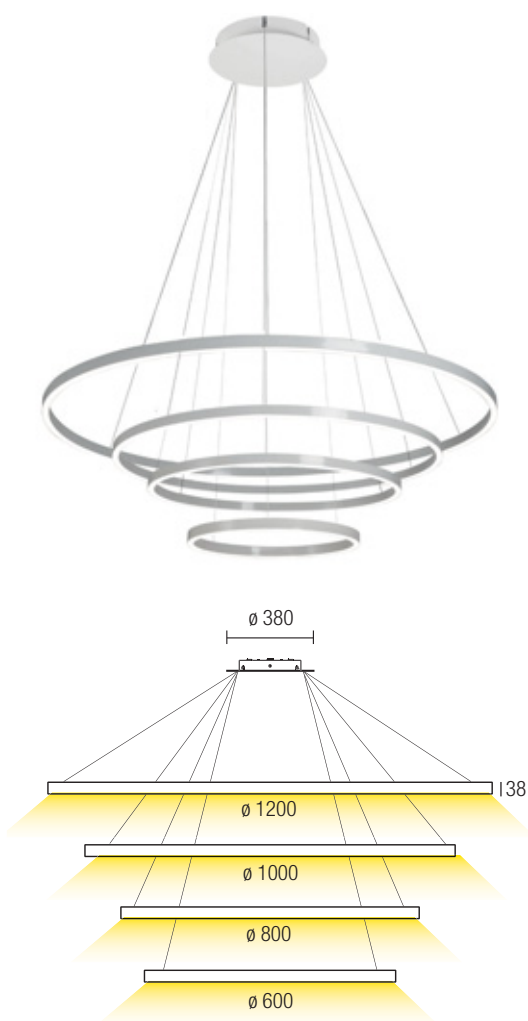

Aura S LED 4 anelli Down



AURA S 60-80-100-120 Down

ON -OFF

DALI 2 PUSH

	822002-3KB	822002-3KBDA
	822001-3KN	822001-3KNDA
	822001-3KG	822001-3KGDA
	822001-3KO	822001-3KODA
	822001-3KBR	822001-3KBRDA

Sorgente
Source

LED

Potenza
Total power

230W

Temperatura di colore
Color temperature

3000K

2700K-4000K
ON DEMAND

Flusso luminoso max.
Lighting output max.

11.500Lm
(50lm/W)

Peso kg
weight kg

8,0

Lunghezza cavi L. max
Cable length L. max

2200mm

   CELL

220-240V 50/60Hz DRIVER INCLUDED





Aura S LED Verticale 1 anello

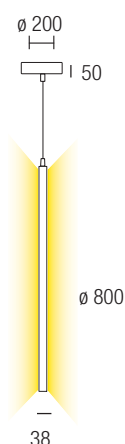
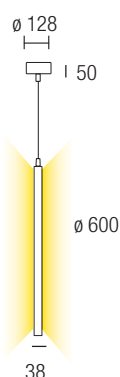
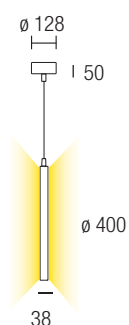

AURA S Verticale 40

ON - OFF

DALI 2 PUSH

	7620VE-3KB	7620VE-3KBDA
	7620VE-3KN	7620VE-3KNDA
	7620VE-3KG	7620VE-3KGDA
	7620VE-3KO	7620VE-3KODA
	7620VE-3KBR	7620VE-3KBRDA

Sorgente
Source

LED

Potenza
Total power

2x20W

Temperatura di colore
Color temperature

3000K

2700K-4000K
ON DEMAND

Flusso luminoso max.
Lighting output max.

2x1000Lm
(50lm/W)

Peso kg
weight kg

1,5

Lunghezza cavi L. max
Cable length L. max

2200mm

   CELL

220-240V 50/60Hz DRIVER INCLUDED

AURA S Verticale 60

ON - OFF

DALI 2 PUSH

	7720VE-3KB	7720VE-3KBDA
	7720VE-3KN	7720VE-3KNDA
	7720VE-3KG	7720VE-3KGDA
	7720VE-3KO	7720VE-3KODA
	7720VE-3KBR	7720VE-3KBRDA

Sorgente
Source

LED

Potenza
Total power

2x30W

Temperatura di colore
Color temperature

3000K

2700K-4000K
ON DEMAND

Flusso luminoso max.
Lighting output max.

2x1500Lm
(50lm/W)

Peso kg
weight kg

2,25

Lunghezza cavi L. max
Cable length L. max

2200mm

   CELL

220-240V 50/60Hz DRIVER INCLUDED

AURA S Verticale 80

ON - OFF

DALI 2 PUSH

	7722VE-3KB	7722VE-3KBDA
	7722VE-3KN	7722VE-3KNDA
	7722VE-3KG	7722VE-3KGDA
	7722VE-3KO	7722VE-3KODA
	7722VE-3KBR	7722VE-3KBRDA

Sorgente
Source

LED

Potenza
Total power

2x30W

Temperatura di colore
Color temperature

3000K

2700K-4000K
ON DEMAND

Flusso luminoso max.
Lighting output max.

2x1500Lm
(50lm/W)

Peso kg
weight kg

3,0

Lunghezza cavi L. max
Cable length L. max

2200mm

   CELL

220-240V 50/60Hz DRIVER INCLUDED

Informazioni tecniche, collegamento elettrico Technical information on electrical connection

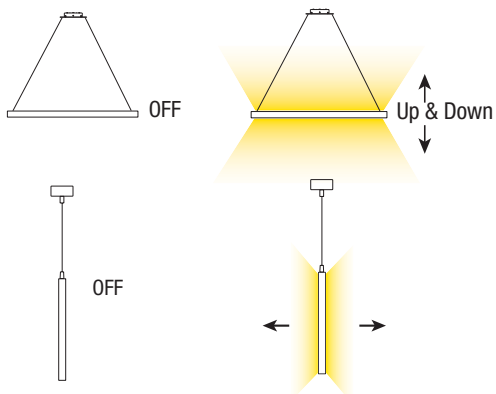

Accensione singola con impianto tradizionale Single ignition with traditional system

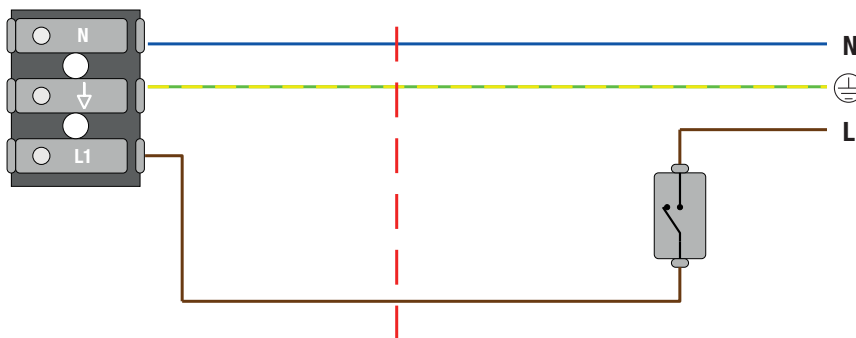

Accensione indipendente, impianto tradizionale + un filo Ø800, Ø1200. Independent ignition, traditional system + one wire Aura Ø800, Ø1200 and two rings (Ø400 + Ø600).

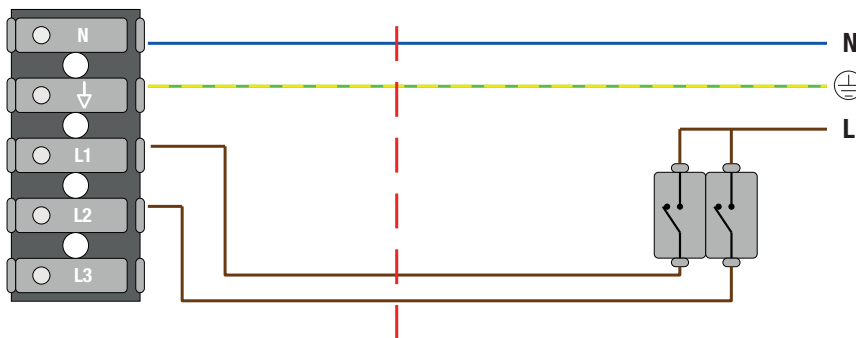
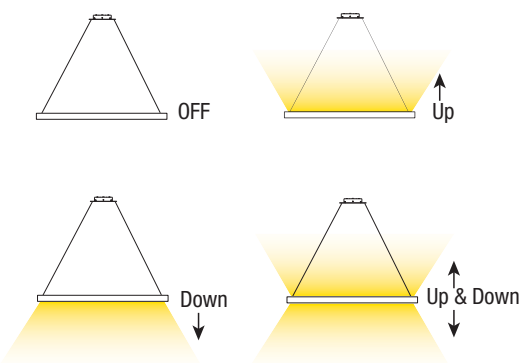

Dimmerabile DALI
Dimmable DALI

Regolazione Dali, impianto tradizionale + due fili Dali regulation, traditional system + two wires

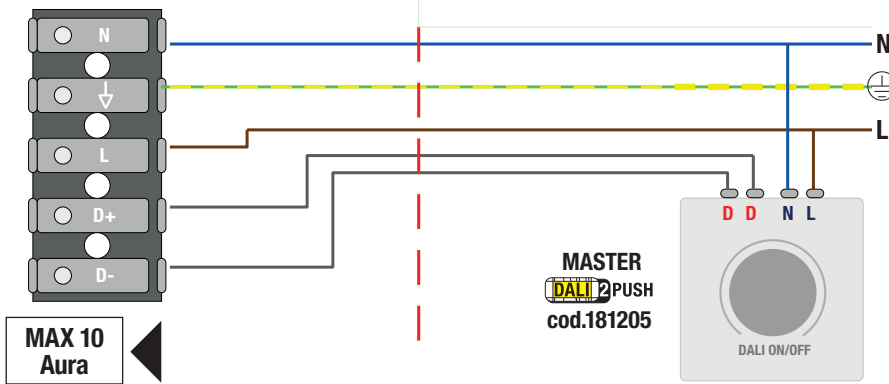
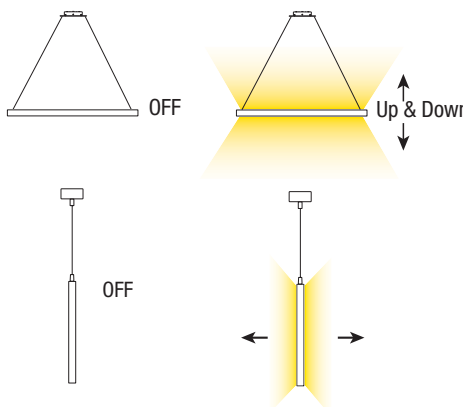

Dimmerabile PUSH
Dimmable PUSH

Regolazione a pulsante con driver Dali, impianto tradizionale + un filo Push button adjustment with Dali driver, traditional system + one wire

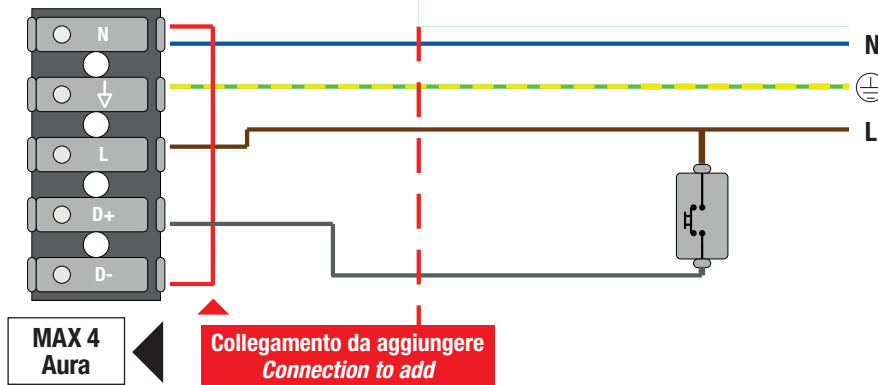
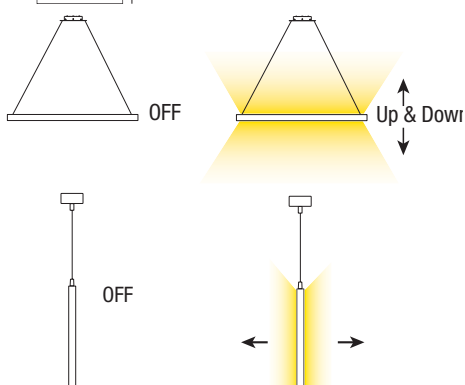



Aura S LED 3 anelli MultiAura



3X
Ø400mm



2X
Ø400mm

1X
Ø600mm



1X
Ø400mm

1X
Ø600mm

1X
Ø800mm

MULTIAURA S Verticale 3X40

ON - OFF

DALI 2 PUSH

	7620ML-3KB	7620VE-3KBDA
	7620ML-3KN	7620VE-3KNDA
	7620ML-3KG	7620VE-3KGDA
	7620ML-3KO	7620VE-3KODA
	7620ML-3KBR	7620VE-3KBRDA

Sorgente
Source

LED

Potenza
Total power 2x60W

Temperatura di colore
Color temperature **3000K**
2700K-4000K
ON DEMAND

Flusso luminoso max.
Lighting output max. 2x3000Lm
(50lm/W)

Peso kg
weight kg 6,1

Lunghezza cavi L. max
Cable length L. max 2200mm

220-240V 50/60Hz DRIVER INCLUDED

MULTIAURA S Verticale 2X40 - 1X60

ON - OFF

DALI 2 PUSH

	7720ML-3KB	7720VE-3KBDA
	7720ML-3KN	7720VE-3KNDA
	7720ML-3KG	7720VE-3KGDA
	7720ML-3KO	7720VE-3KODA
	7720ML-3KBR	7720VE-3KBRDA

Sorgente
Source

LED

Potenza
Total power 2x70W

Temperatura di colore
Color temperature **3000K**
2700K-4000K
ON DEMAND

Flusso luminoso max.
Lighting output max. 2x3500Lm
(50lm/W)

Peso kg
weight kg 6,4

Lunghezza cavi L. max
Cable length L. max 2200mm

220-240V 50/60Hz DRIVER INCLUDED

MULTIAURA S Verticale 1X40-1X60-1X80

ON - OFF

DALI 2 PUSH

	7722ML-3KB	7722VE-3KBDA
	7722ML-3KN	7722VE-3KNDA
	7722ML-3KG	7722VE-3KGDA
	7722ML-3KO	7722VE-3KODA
	7722ML-3KBR	7722VE-3KBRDA

Sorgente
Source

LED

Potenza
Total power 2x80W

Temperatura di colore
Color temperature **3000K**
2700K-4000K
ON DEMAND

Flusso luminoso max.
Lighting output max. 2x4000Lm
(50lm/W)

Peso kg
weight kg 7

Lunghezza cavi L. max
Cable length L. max 2200mm

220-240V 50/60Hz DRIVER INCLUDED



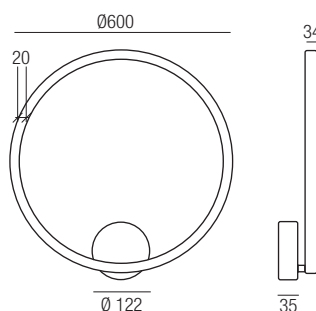
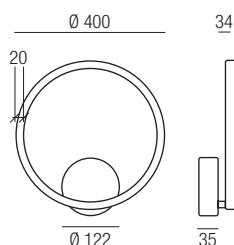

AURA W 40

ON - OFF

DALI 2 PUSH

	8020AP-3KB	8020AP-3KBDA
	8020AP-3KN	8020AP-3KNDA
	8020AP-3KG	8020AP-3KGDA
	8020AP-3KO	8020AP-3KODA
	8020AP-3KBR	8020AP-3KBRDA

Sorgente
Source



Potenza
Total power 2x20W

Temperatura di colore
Color temperature **3000K**
2700K-4000K
ON DEMAND

Flusso luminoso max.
Lighting output max. 2x1000Lm
(50lm/W)

Peso kg
weight kg 1,5

Lunghezza cavi L. max
Cable lenght L. max 2200mm

220-240V 50/60Hz DRIVER INCLUDED

AURA W 60

ON - OFF

DALI 2 PUSH

	8120AP-3KB	8120AP-3KBDA
	8120AP-3KN	8120AP-3KNDA
	8120AP-3KG	8120AP-3KGDA
	8120AP-3KO	8120AP-3KODA
	8120AP-3KBR	8120AP-3KBRDA

Sorgente
Source



Potenza
Total power 2x30W

Temperatura di colore
Color temperature **3000K**
2700K-4000K
ON DEMAND

Flusso luminoso max.
Lighting output max. 2x1500Lm
(50lm/W)

Peso kg
weight kg 2,25

Lunghezza cavi L. max
Cable lenght L. max 2200mm

220-240V 50/60Hz DRIVER INCLUDED





Aura Track Verticale 1 anello

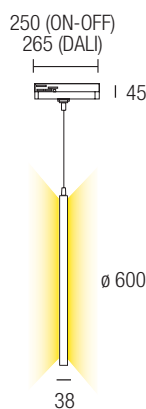
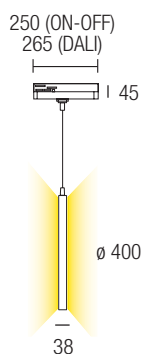

AURA Track verticale 40

ON -OFF

DALI 2 PUSH

	7620VTR-3KB	7620VTR-3KBDA
	7620VTR-3KN	7620VTR-3KNDA
	7620VTR-3KG	7620VTR-3KGDA
	7620VTR-3KO	7620VTR-3KODA
	7620VTR-3KBR	7620VTR3KBRDA

Sorgente
Source



Potenza
Total power 2x20W

Temperatura di colore
Color temperature **3000K**
2700K-4000K
ON DEMAND

Flusso luminoso max.
Lighting output max. 2x1000Lm
(50lm/W)

Peso kg
weight kg 1,5

Lunghezza cavi L. max
Cable lenght L. max 2200mm

   CELL

220-240V 50/60Hz DRIVER INCLUDED

AURA Track verticale 60

ON -OFF

DALI 2 PUSH

	7720VTR-3KB	7720VTR-3KBDA
	7720VTR-3KN	7720VTR-3KNDA
	7720VTR-3KG	7720VTR-3KGDA
	7720VTR-3KO	7720VTR-3KODA
	7720VTR-3KBR	7720VTR3KBRDA

Sorgente
Source



Potenza
Total power 2x30W

Temperatura di colore
Color temperature **3000K**
2700K-4000K
ON DEMAND

Flusso luminoso max.
Lighting output max. 2x1500Lm
(50lm/W)

Peso kg
weight kg 2,25

Lunghezza cavi L. max
Cable lenght L. max 2200mm

   CELL



220-240V 50/60Hz DRIVER INCLUDED



Pendel Serie

Cavo in pvc da ordinare separatamente, rivestito textile 2x0,75mm2 H03VV lunghezza 5 metri.

PVC cable to be ordered separately, textile coating 2x0.75mm2 H03VV, 5 meters long.

Color	H mm	Code
 Oro Gold	5000	25.330
 Cromo Chrome	5000	25.345



LED
inside

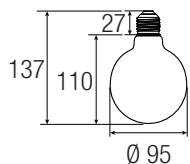
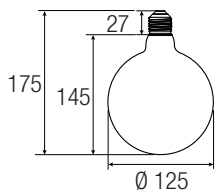
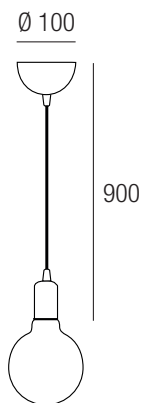

Solo pendel
Only pendel

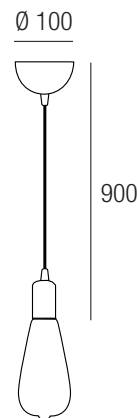
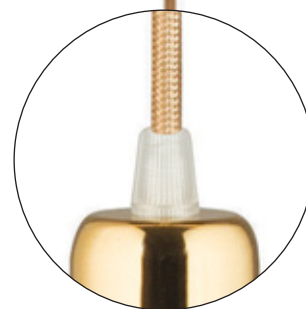

LED
inside



LED
inside



LED
inside

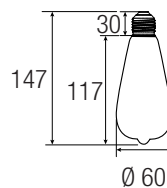

LED
inside



Pendelglobo inox



Color	Diffusor
 Cromo Chrome	 Trasparente Transparent

Code	Ø mm
555287.KIT	125
555338.KIT	95

Sorgente Source	
Potenza Total power	5W
Temperatura di colore Color temperature	3000K
Flusso luminoso Lighting output	550Lm
Lunghezza cavi L. max Cable lenght L. max	900mm

   S+L
220-240V 50/60Hz

Pendelglobo inox



Color	Diffusor
 Cromo Chrome	 Trasparente Transparent
 Cromo Chrome	

Code	Ø mm
555375.KIT	125
555348.KIT	95

Sorgente Source	
Potenza Total power	5W
Temperatura di colore Color temperature	3000K
Flusso luminoso Lighting output	550Lm
Lunghezza cavi L. max Cable lenght L. max	900mm

   S+L
220-240V 50/60Hz

Pendelglobo Antico



Color	Diffusor
 Oro Gold	 Trasparente Transparent
 Vintage Vintage	

Code	Ø mm
557216-VT	125
557217-VT	95

Sorgente Source	
Potenza Total power	5W
Temperatura di colore Color temperature	3000K
Flusso luminoso Lighting output	550Lm
Lunghezza cavi L. max Cable lenght L. max	900mm

   S+L
220-240V 50/60Hz

Pendelglobo Vintage

Color	Diffusor
 Oro Gold	 Trasparente Transparent
 Vintage Vintage	

Code	Ø mm
555349.KIT	125
555349/S.KIT	95

Sorgente Source	
Potenza Total power	5W
Temperatura di colore Color temperature	3000K
Flusso luminoso Lighting output	550Lm
Lunghezza cavi L. max Cable lenght L. max	900mm

   S+L
220-240V 50/60Hz

LED Zero - Mario

LED Zero con accessorio ROS/TON/4/B
Zero LED with ROS/TON/4/B accessory



LED
inside



LED
inside

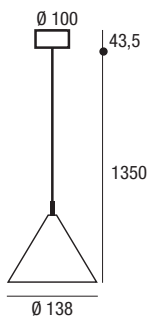

LED ZERO 20

□ SL374/WH

Sorgente Source	LED
Potenza Total power	20W
Temperatura di colore Color temperature	3000K
Flusso luminoso Lighting output	1400Lm
Lunghezza cavi L. max Cable lenght L. max	1000 mm

⚡ CE Ⓢ IK07 IP20 CELL

220-240V 50/60Hz

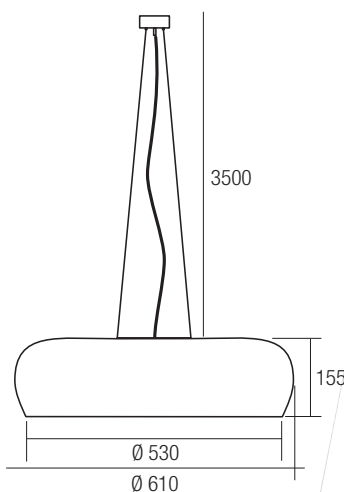

↑ Regolabile in altezza
↓ Height adjustable

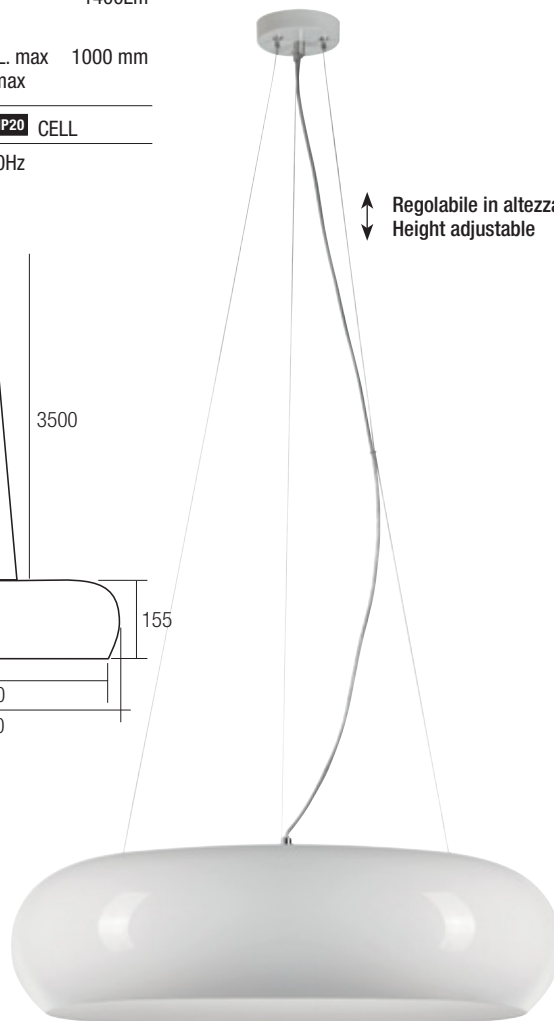

not
included

MARIO - PMMA

Color	Diffusor
□ Bianco White	□ Plexiglass bianco White plexiglass

Code

260004

Sorgente
Source



Lunghezza cavi L. max
Cable lenght L. max

⚡ CE Ⓢ IK07 IP20 S

220-240V 50/60Hz

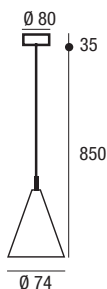

LED ZERO 5

□ SL372/WH
■ SL372/BL

Sorgente Source	LED
Potenza Total power	5W
Temperatura di colore Color temperature	3000K
Flusso luminoso Lighting output	850Lm
Lunghezza cavi L. max Cable lenght L. max	1000 mm

⚡ CE Ⓢ IK07 IP20 CELL

220-240V 50/60Hz

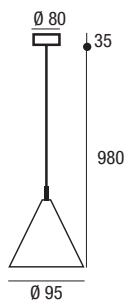

LED ZERO 10

□ SL373/WH
■ SL373/BL

Sorgente Source	LED
Potenza Total power	10W
Temperatura di colore Color temperature	3000K
Flusso luminoso Lighting output	1200Lm
Lunghezza cavi L. max Cable lenght L. max	1000mm

⚡ CE Ⓢ IK07 IP20 CELL

220-240V 50/60Hz

Geranio 3S - Geranio 7S Ciclamino S



LED
inside



LED
inside



LED
inside

Geranio 3 S

Color

 Oro
Gold

Diffusor

 Opale
Opal

Code

R-9078-3

Sorgente
Source

 15W **LED**

   CELL

Geranio 7 S

Color

 Oro
Gold

Diffusor

 Opale
Opal

Code

R-9078-7

Sorgente
Source

 35W **LED**



   CELL





Glicine S



Non incluso
Not included



Glicine S
Color Cromo Chrome
Diffusor Trasparente Transparent
Code R-9098-14CL
Sorgente Source  **12X G9**
    S

Glicine S
Color Cromo Chrome
Diffusor Fumè Smoked
Code R-9098-14FUME
Sorgente Source  **12X G9**
    S

Sospensioni - Suspension

Idee luce · Decorativo  segno

Agave C - Diphylleia S Orchidea S



Non incluso
Not included

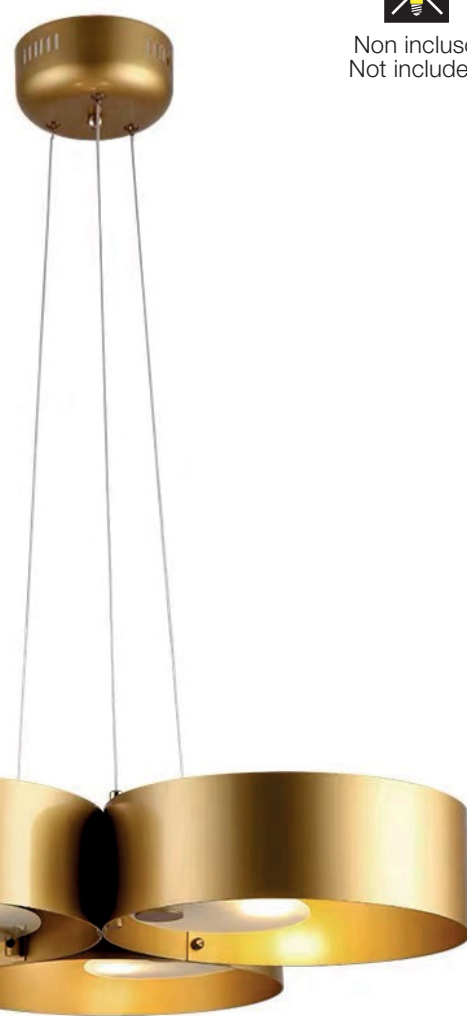
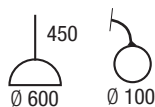

agave C

Color



Diffusor



Code

R-9067-6

Sorgente
Source



6X
G9

6X
G9

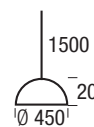
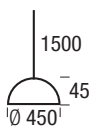

Orchidea S

Color



Diffusor



Code

R-9330

Sorgente
Source



1X
E27



Diphylleia S

Color



Diffusor

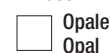

Code

R-9317

Sorgente
Source



3X
G9



Ibisco S - Lilla S Calla S



Non incluso
Not included

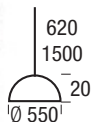

Ibisco S
Color Cromo Chrome Bianco White
Diffusor Opale Opal
Code R-9435
Sorgente Source **1X E27**
⊕ CE Ⓢ IK07 IP20 S

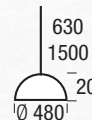

Lilla S
Color Cromo Chrome Opale Opal
Diffusor Opale Opal
Code R-9433
Sorgente Source **4X E27**
⊕ CE Ⓢ IK07 IP20 S

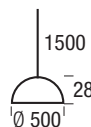

Calla S
Color Nero Black Nero Black
Diffusor Nero Black
Code R-9336
Sorgente Source **4X E27**
⊕ CE Ⓢ IK07 IP20 S

Sospensioni - Suspension

Idee luce · Decorativo **segno**

Gerbera S - Lavanda S Hemisphere S



Non incluso
Not included

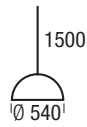

Gerbera S
Color
■ Nero
Black
□ Opale
Opal

Code
R-9280-6BK
Quelle
Source **6X**
E27

S

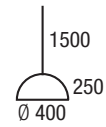
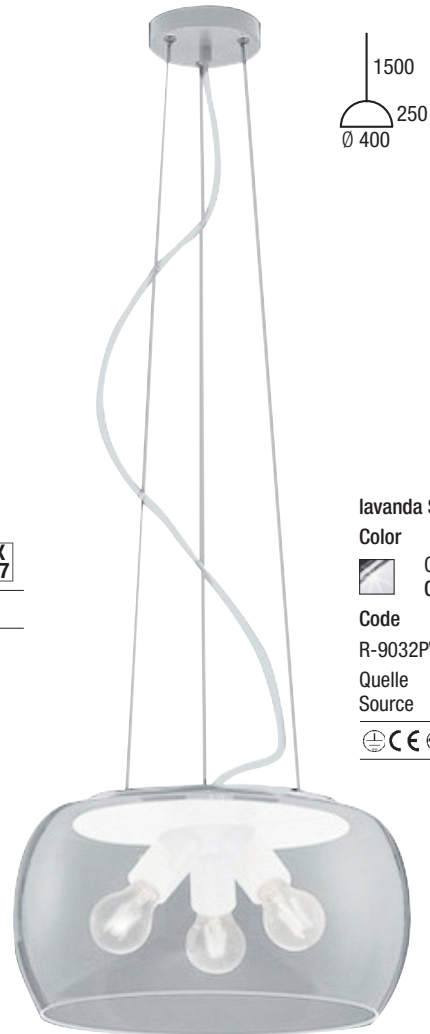

lavanda S
Color
■ Cromo
Chrome
□ Trasparente
Transparent

Code
R-9032PWH
Quelle
Source **3X**
E27

S

Sospensioni - Suspension

Idee luce · Decorativo segno

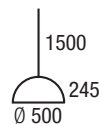
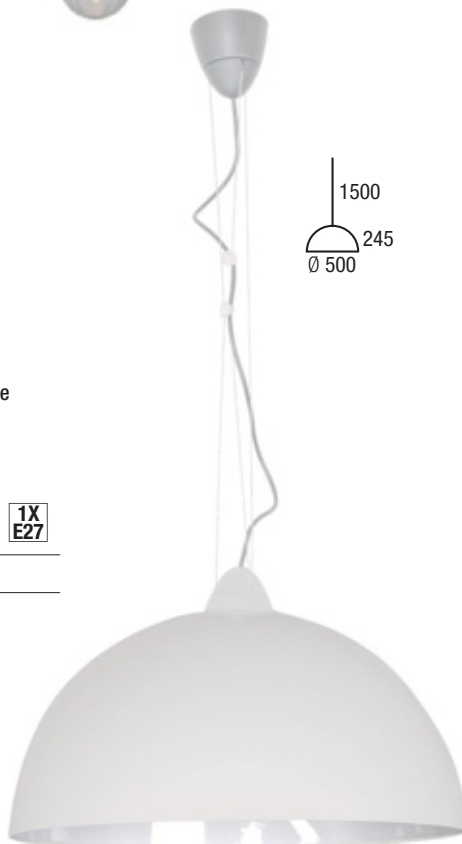

Hemisphere S
Color
□ Opale
Opal
□ Opale
Opal

Code
R-SD9652-W
Quelle
Source **1X**
E27

S

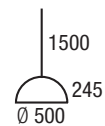

Hemisphere S
Color
■ Nero
Black
■ Nero
Black

Code
R-SD9652-B
Quelle
Source **1X**
E27

S

Girasole



Colore disponibile di serie
Color available as standard



Nero
Black

Colore a richiesta
Color on request



Bianco
White

Girasole plafone



Non incluso
Not included

Una curva caratterizza questa serie di lampade in coordinato a plafone, parete, piantra e tavolo, prodotte in metallo dallo stile industrial chic disponibili nella finitura nero. Sorgenti luminose non comprese.

A curve characterizes this series of coordinated ceiling, wall, floor and table lamps, produced in metal with an industrial chic style available in a black finish. Light sources not included.

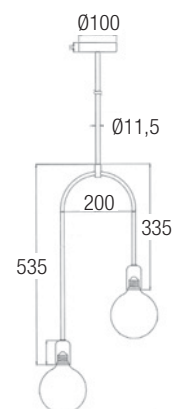
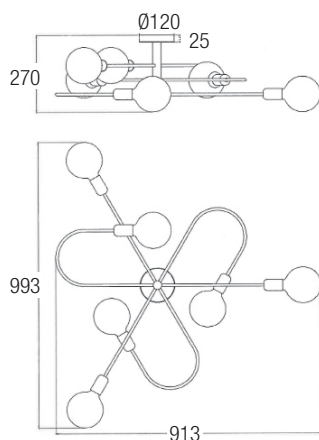
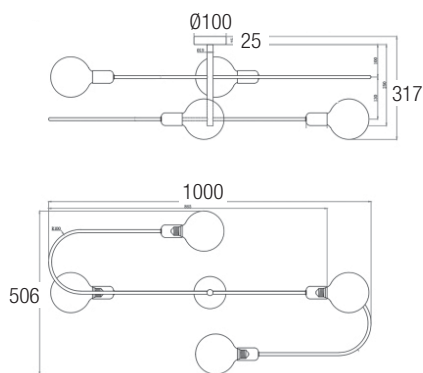

Girasole Plafone 4

Color

Nero
Black

Code

R-SD9651-C4

Sorgente
Source



S

220-240V 50/60Hz

Girasole Plafone 6

Color

Nero
Black

Code

R-SD9651-C6

Sorgente
Source



S

220-240V 50/60Hz

Girasole Plafone 2

Color

Nero
Black

Code

R-SD9651-S2

Sorgente
Source



S

220-240V 50/60Hz



Girasole piantana, tavolo, applique



Non incluso
Not included

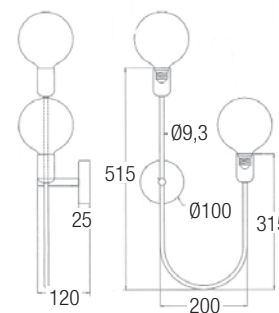
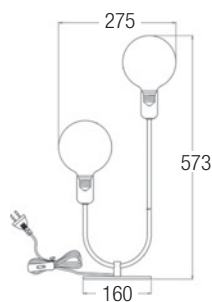
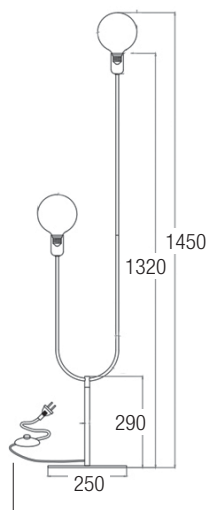

Girasole Piantana 4

Color

 Nero
Black

Code

R-SD9651-F4

Sorgente
Source



4X
E27

    S

220-240V 50/60Hz

Girasole Tavolo 2

Color

 Nero
Black

Code

R-SD9651-T2

Sorgente
Source



2X
E27

    S

220-240V 50/60Hz

Girasole Applique 2

Color

 Nero
Black

Code

R-SD9651-W2

Sorgente
Source



2X
E27

    S

220-240V 50/60Hz

Anthurium LED

Flex applique

Lisianthus W



Nicht enthalten
Non inclus

Applique da parete, con braccio snodato e direzionale.
Lampade da interni, ideali come testaletto e per creare effetti luminosi decorativi.
Corpo in acciaio cromato, sorgente luminosa LED compresa, sorgente per portalampada E27 non compresa.

Wall applique, with articulated and directional arm.
Indoor lamps, ideal as a bed headboard and to create decorative lighting effects.
Body in chromed steel, LED light source included, source for E27 lamp holder not included.

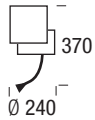

LED
inside

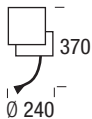

LED
inside

Anthurium WB LED

Color Diffusor
Cromo Nero
Chrome Black

Code
R-SD9463WABK

Sorgente Source 3W **LED**

Sorgente Source **1X E27**

Anthurium WW LED

Color Diffusor
Cromo Bianco
Chrome White

Code
R-SD9463WAWH

Sorgente Source 3W **LED**

Sorgente Source **1X E27**

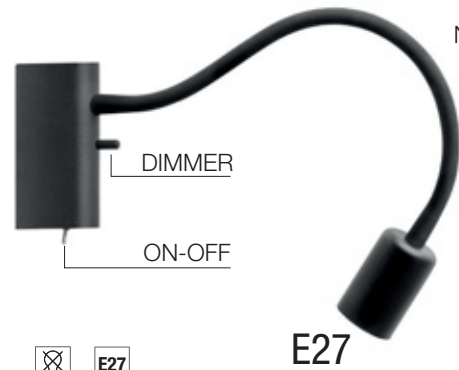

FLEX applique Black

Color Code
Nero Black 9768

Sorgente Source **E27**

Lunghezza stelo L. max stem length L. max 510 mm

220-240V 50/60Hz

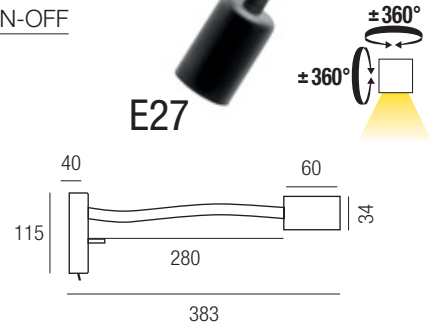

Faretto da parete orientabile, con braccio snodato e direzionale.

Lampade da interni, ideali come testaletto e per creare effetti luminosi decorativi. Corpo in acciaio verniciato con tubo protettivo plastico nero, sorgente luminosa non compresa.

Adjustable wall spotlight, with articulated and directional arm.

Indoor lamps, ideal for headboards and for creating decorative light effects. LED source and power supply included, with switch. Body in painted steel with protective black plastic tube, light source not included.

Applique da parete da interni, ideali per le zone umide. Corpo in acciaio cromato. Sorgente per portalampada E27 non compresa.

Interior wall wall light, ideal for wetlands. Chromed steel body. Source for E27 lamp holder not included.

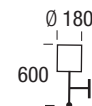

not included

Lisianthus W

Color Diffusor
Cromo Bianco
Chrome White

Code
R-9434W

Sorgente Source **1X E27**

Giacinto - Ego - Baby



Non incluso
Not included



Giacinto

Color	Code
Bianco White	4010/50/N
Nero Black	4010/50/NN
Grigio Grey	4010/50/NG

Sorgente Source Non inclusa
Not included

2X
R7S

IK07 IP20 S

Per i colori Nero e Grigio tempo di consegna 30gg.
For Black and Gray colors delivery time 30 days.

220-240V 50/60Hz

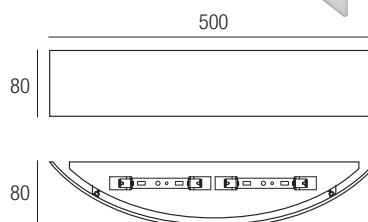

Ego 15

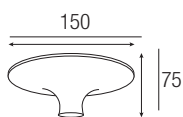

Ego 25

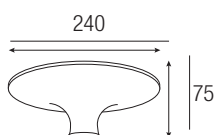

Ego 15

Color	Code	Euro cad.
Bianco White	32200	15,00

Sorgente Source

S

220-240V 50/60Hz

Ego 25

Color	Code	Euro cad.
Bianco White	32210	25,00
Grigio Grey	32211	25,00

Sorgente Source

S

220-240V 50/60Hz

Lampade da soffitto e da parete, semplici e moderne, dal design piacevole. Emettono una luce diffusa e sono adatte ad ambienti domestici e per illuminare corridoi e sale di attesa. Sorgenti luminose non comprese.

Ceiling and wall lamps, simple and modern, with a pleasant design. They emit a diffused light and are suitable for domestic environments and for illuminating corridors and waiting rooms. Light sources not included.

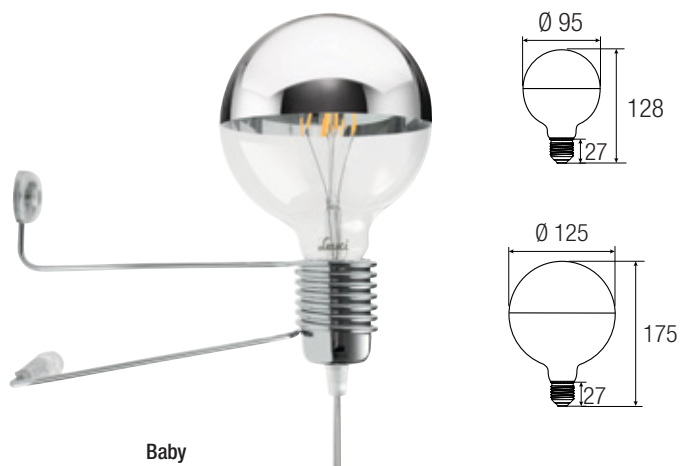

Baby

Color	Cod.
Cromo Chrome	150004
Oro Gold	150005
Rame Copper	150006

Sorgente Source

S

220-240V 50/60Hz

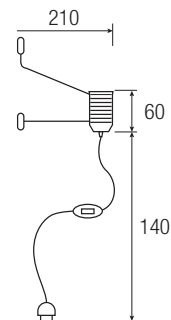

Jodie S - Glass



Non incluso
Not included



Sospensioni in vetro per luce diffusa adatto per applicazioni da interno con diffusore in vetro incamiciato bianco opale, rosone e aggancio lampada cromo, cavo trasparente, per installazioni singole o multiple tramite l'utilizzo dei rosone multi lampada da ordinare separatamente.
Sorgenti luminose non comprese.

Glass suspensions for diffused light for indoor applications with opal white cased glass diffuser, chrome ceiling rose and lamp coupling, transparent cable, for single or multiple installations using multi-lamp ceiling rose to be ordered separately.
Light sources not included.

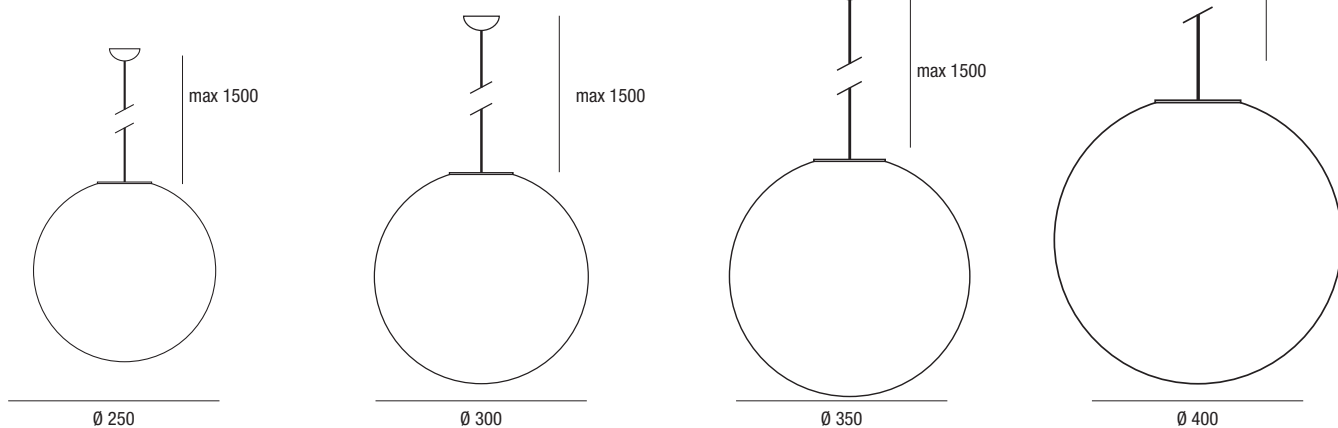

Jodie S25

Color diffusor
 Cromo Vetro bianco opale
 Chrome Opal white glass

Code
R-GY3125CW

Sorgente E27
 Source E27
 220-240V 50/60Hz

Jodie S30

Color diffusor
 Cromo Vetro bianco opale
 Chrome Opal white glass

Code
R-GY3130CW

Sorgente E27
 Source E27
 220-240V 50/60Hz

Jodie S35

Color diffusor
 Cromo Vetro bianco opale
 Chrome Opal white glass

Code
R-GY3135CW

Sorgente E27
 Source E27
 220-240V 50/60Hz

Jodie S40

Color diffusor
 Cromo Vetro bianco opale
 Chrome Opal white glass

Code
R-GY3140CW

Sorgente E27
 Source E27
 220-240V 50/60Hz



Dispositivo meccanico per la sospensione multipla, consente di sospendere tre o cinque apparecchi di illuminazione della serie Jodie S.

È composto da un'attacco meccanico a plafone dotato di serracavi, doppi morsetti di connessione alla rete di alimentazione elettrica per accensioni separate ed una copertura in metallo verniciato.

**Non può essere utilizzato per la serie:
JERI S - Murano**

Mechanical device for multiple suspension, allows you to suspend three or five lighting fixtures from the Jodie S series.

It consists of a mechanical ceiling attachment equipped with cable clamps, double terminals for connection to the mains power supply for separate switching on and a painted metal cover.

**Cannot be used for series:
JERI S - Murano**

Serie Jodie S



Jodie S25 - Ø250mm

Codice Code

R-GY3125CW

Peso Weight

1 Kg



Jodie S30 - Ø300mm

Codice Code

R-GY3130CW

Peso Weight

2 Kg



Jodie S35 - Ø350mm

Codice Code

R-GY3135CW

Peso Weight

2,5 Kg



Jodie S40 - Ø400mm

Codice Code

R-GY3140CW

Peso Weight

3 Kg

Tasselli e viti non compresi. Per l'installazione a soffitto utilizzare tasselli e viti adeguati al peso totale della lampada e alla superficie su cui andrà ancorata.

Plug and screws are not included. Ceiling installation use plug and screws adapted to the total weight of the lamp and the surface on which will be anchored.

Esempi di installazione per Jodie S Ø250, Ø300 e Ø350
 Example of installation for Jodie S Ø250, Ø300 and Ø350

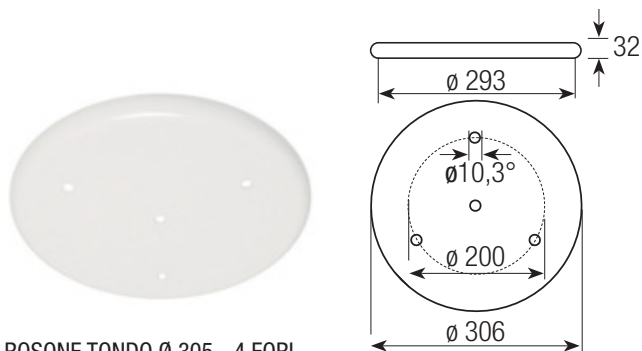
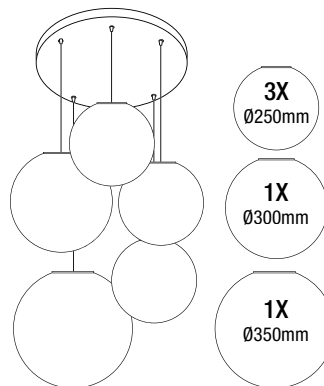
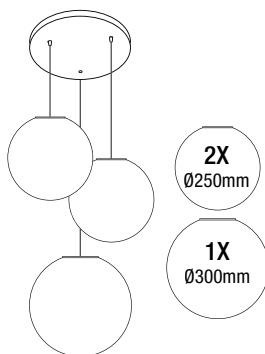

ROSONE TONDO Ø 305 - 4 FORI
 ROUND CEILING ROSE Ø 305 - 4 HOLES

Color	Code
<input type="checkbox"/> Bianco White	ROS/TON/4/B

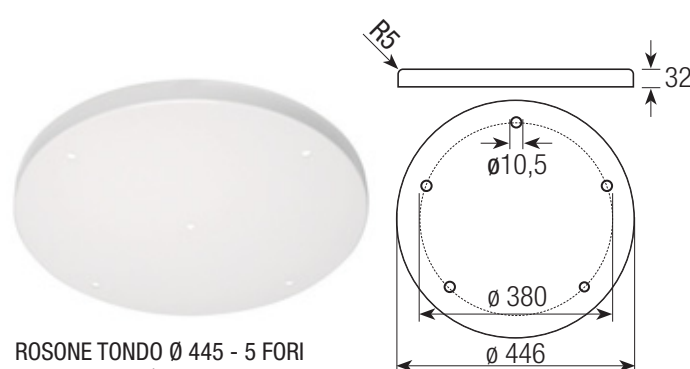

ROSONE TONDO Ø 445 - 5 FORI
 ROUND ROSE Ø 445 - 5 HOLES

Color	Code
<input type="checkbox"/> Bianco White	ROS/TON/5/B

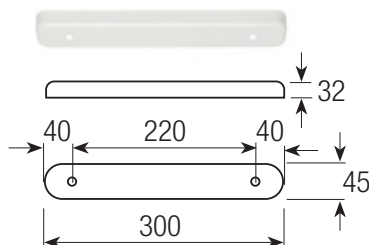
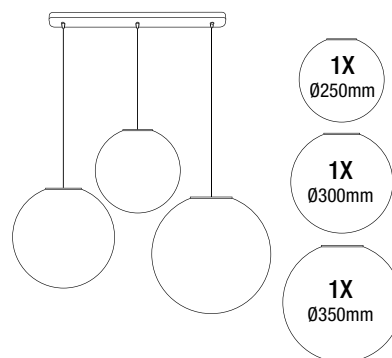
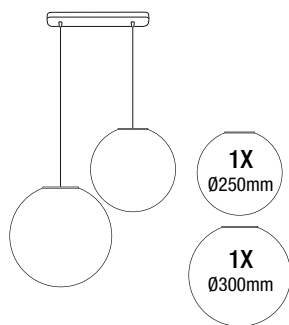

ROSONE RETTANGOLARE 2 FORI
 2-HOLE RECTANGULAR CEILING ROSE

Color	Code
<input type="checkbox"/> Bianco White	ROS/RET/2/B

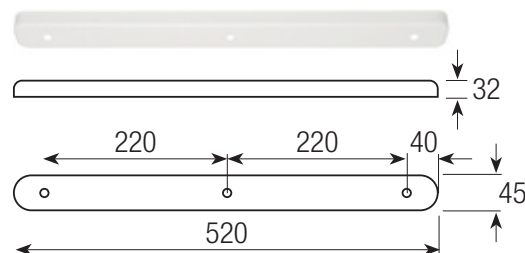

ROSONE RETTANGOLARE 3 FORI
 3-HOLE RECTANGULAR CEILING ROSE

Color	Code
<input type="checkbox"/> Bianco White	ROS/RET/3/B

Vetro palla S Vetro/Glass



Non incluso
Not included

Sospensioni in vetro per una luce diffusa per applicazioni da interno con diffusore in vetro trasparente, Ambra, cromo scuro, azzurrato e fumè rigato e rosone in tinta e cavo intrecciato. Sorgenti luminose non comprese.

Glass suspensions for diffused light for indoor applications with diffuser in transparent, amber, dark chrome, blued and striped smoked glass and matching rosette and braided cable. Light sources not included.

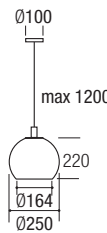
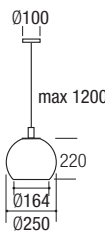
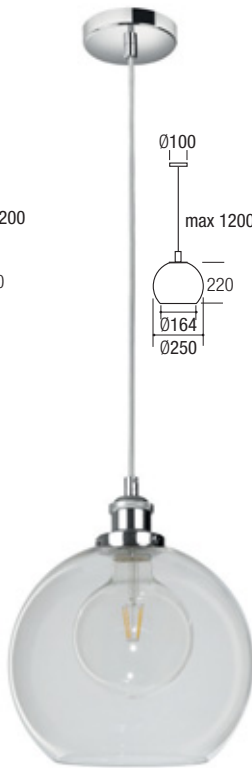
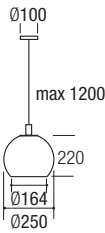
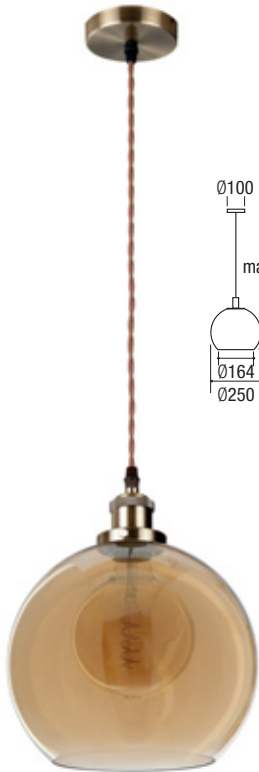

Vetro palla Dark Crome

Color Nero Black Diffusor Cromo scuro Dark Chrome

Code
R-GY3104SM
Sorgente **1X E27**

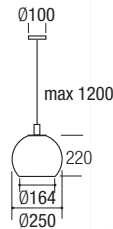
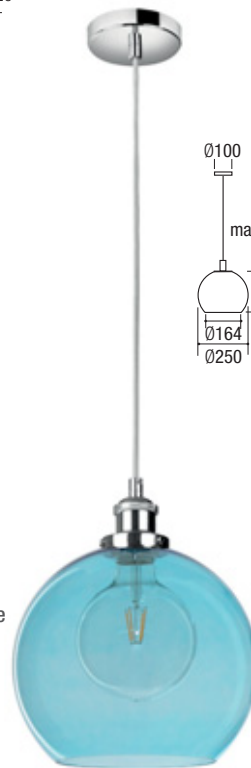

Vetro palla Sky blu

Color Cromo Chrome Diffusor Azzurro Sky blu

Code
R-GY3104LB
Sorgente **1X E27**

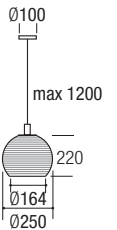
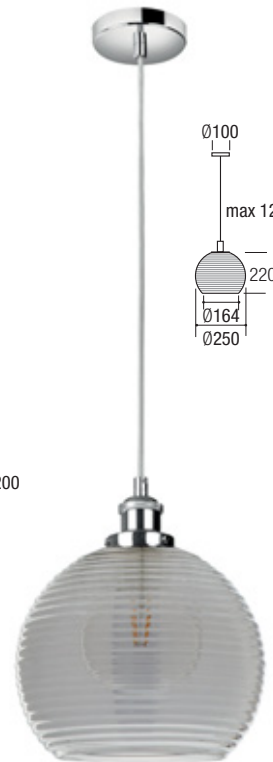

Vetro palla Fumè rigato

Color Cromo Chrome Diffusor Fumè Smoked

Code
R-GY3152SM
Sorgente **1X E27**



Vetro palla Ambra

Color Rame Copper Diffusor Ambra Amber

Code
R-GY3104AM
Sorgente **1X E27**



Vetro palla Trasparente

Color Cromo Chrome Diffusor Trasparente Transparent

Code
R-GY3104PTL
Sorgente **1X E27**



Vittoria, Fatua



OGGETTO REALIZZATO
CON VETRO
PRODOTTO A
MURANO
MADE IN ITALY



Vittoria



Fatua



Non incluso
Not included



Vittoria

Color diffusor
 Bianco White
 Vetro opale Opal glass

Code Ø L
 51304550 320
 51304750 450

Sorgente Source 1X E14 1X E27

Vittoria 2 Ø 320 - 1x E14+1E27
Vittoria 1 Ø 450 - 5x E27

Potenza Total power E14 - max 40W
 E27 - max 60W

220-240V 50/60Hz

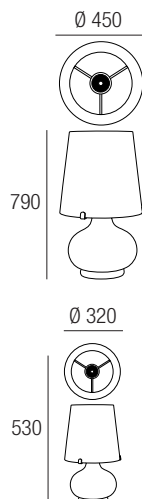

LED
inside

Fatua 1000 COLORS

Color diffusor
 Vetro trasparente Transparent glass
 Vetro opale Opal glass

Code
 820002

Sorgente Source **LED**
 Potenza Total power 21W
 Temperatura di colore Color temperature **RGB**
 Flusso luminoso Lighting output 240Lm

220-240V 50/60Hz

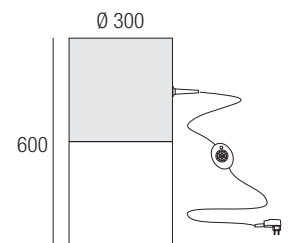

Jeri S

OGGETTO REALIZZATO
CON VETRO
PRODOTTO A
MURANO
MADE IN ITALY



Non incluso
Not included



Apparecchi di illuminazione ad applique per una luce diffusa per applicazioni da interno con diffusore in vetro incamiciato bianco opale prodotto mediante lo storico processo produttivo veneziano di soffiatura a bocca e molatura manuale. La manutenzione ordinaria dell'apparecchio è garantita da un dispositivo meccanico di sgancio del diffusore stesso dalla montatura elettrica. Sorgenti luminose non comprese.

Wall lighting appliances for a diffused light for interior applications with diffuser made of opal white encased glass produced using the historical Venetian process of glass blowing and manual grinding.

Routine maintenance of the appliance is guaranteed by a mechanical release device of the diffuser from the electric fitting.

Light sources not included.

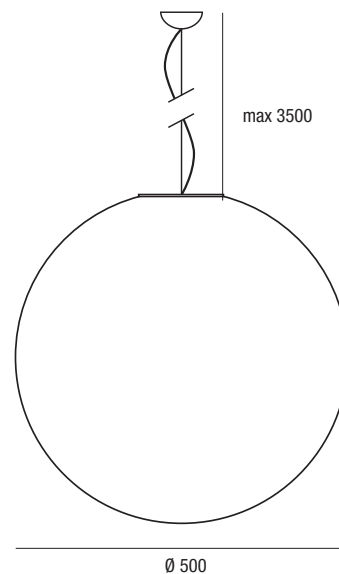
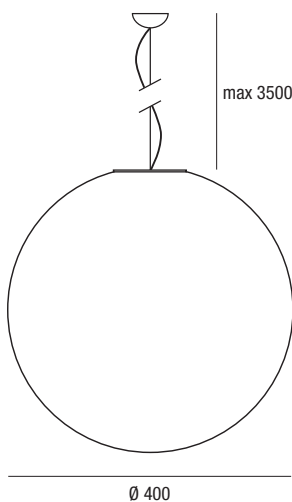
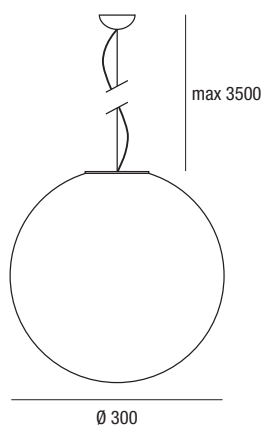

Jery S2

Color diffusor
 Bianco White
 Vetro bianco opale Opal white glass

Code

646/S2

Sorgente Source  

220-240V 50/60Hz

Jery S1

Color diffusor
 Bianco White
 Vetro bianco opale Opal white glass

Code

646/S1

Sorgente Source  

220-240V 50/60Hz

Jery S3

Color diffusor
 Bianco White
 Vetro bianco opale Opal white glass

Code

646/S3

Sorgente Source  

220-240V 50/60Hz



Aki, Cupo



Non incluso
Not included

OGGETTO REALIZZATO
CON VETRO
PRODOTTO A
MURANO
MADE IN ITALY

Applique per una luce diffusa per applicazioni da interno con vetro soffiato triplex lucido e satinato con parti metalliche laccate bianche, prodotto mediante lo storico processo produttivo veneziano di soffiatura a bocca e molatura manuale, il diffusore è lavorato artigianalmente mediante un sofisticato processo di ricottura e formatura ad alta temperatura. Sorgenti luminose non comprese.

Wall lamp for diffused light for indoor applications with glossy and satin triplex blown glass with white lacquered metal parts, produced through the historic Venetian production process of mouth blowing and manual grinding, the diffuser is handcrafted through a sophisticated annealing and forming process at high temperature. Light sources not included.

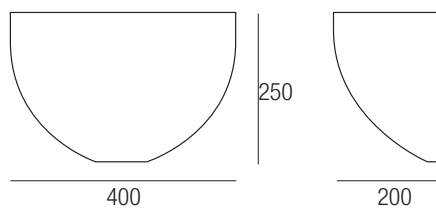
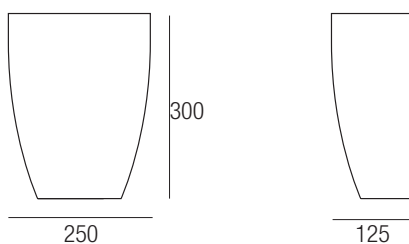

Aki

Color diffusor

- Bianco
White
- Vetro bianco opale
Opal white glass

Code

APAKI300BCS

Sorgente
Source



220-240V 50/60Hz

Cupo

Color diffusor

- Bianco
White
- Vetro bianco opale
Opal white glass

Code

APCUP0400BCS

Sorgente
Source



220-240V 50/60Hz

Font, Milu

OBJECT MADE
WITH GLASS
PRODUCT A
MURANO
MADE IN ITALY



Non incluso
Not included

Applique per una luce diffusa per applicazioni da interno con vetro soffiato triplex lucido e satinato con parti metalliche laccate bianche, prodotto mediante lo storico processo produttivo veneziano di soffiatura a bocca e molatura manuale, il diffusore è lavorato artigianalmente mediante un sofisticato processo di ricottura e formatura ad alta temperatura.

Sorgenti luminose non comprese.

Wall lamp for diffused light for indoor applications with glossy and satin triplex blown glass with white lacquered metal parts, produced through the historic Venetian production process of mouth blowing and manual grinding, the diffuser is handcrafted through a sophisticated annealing and forming process at high temperature.

Light sources not included.

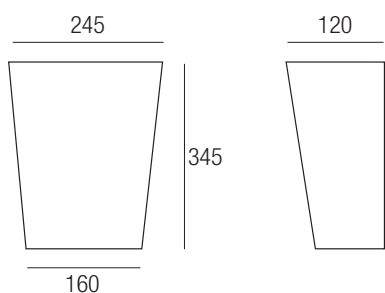

Font

Color diffusor

- Bianco White Vetro bianco opale Opal white glass

Code

APFONT340BCS

Sorgente
Source



⊕ CE IK07 IP20 S

220-240V 50/60Hz

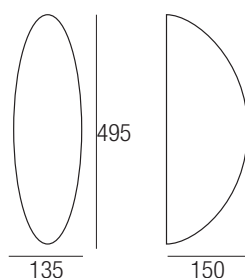

Milu

Color diffusor

- Bianco White Vetro bianco opale Opal white glass

Code

APMILU500BCS

Sorgente
Source



⊕ CE IK07 IP20 S

220-240V 50/60Hz

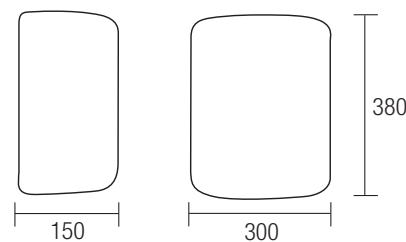
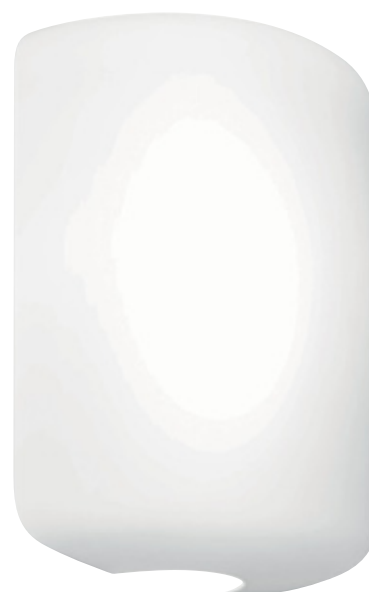

ARIETE Quadro

Color diffusor

- Bianco White Vetro bianco opale Opal white glass

Code

APLND300BCS

Sorgente
Source



⊕ CE IK07 IP20 S

220-240V 50/60Hz

Ariete tondo



Non incluso
Not included



Serie di Lampade a plafone o parete, caratterizzate da una forma morbida e piacevole e con un'ottima diffusione della luce grazie al diffusore in vetro soffiato bianco, con attacco E27 singolo per ARIETE 250 e ARIETE MEZZA SFERA o con attacco E27 doppio per le altre versioni è possibile equipaggiarle di sorgente luminosa a LED (non compresa).

Series of ceiling or wall lamps, featuring a soft and pleasant shape and excellent light diffusion thanks to the white blown glass shade, with single E27 socket for ARIETE 250 and ARIETE MEZZA SFERA or with double E27 holder for the other versions, they may be fitted with LED light source (not included).

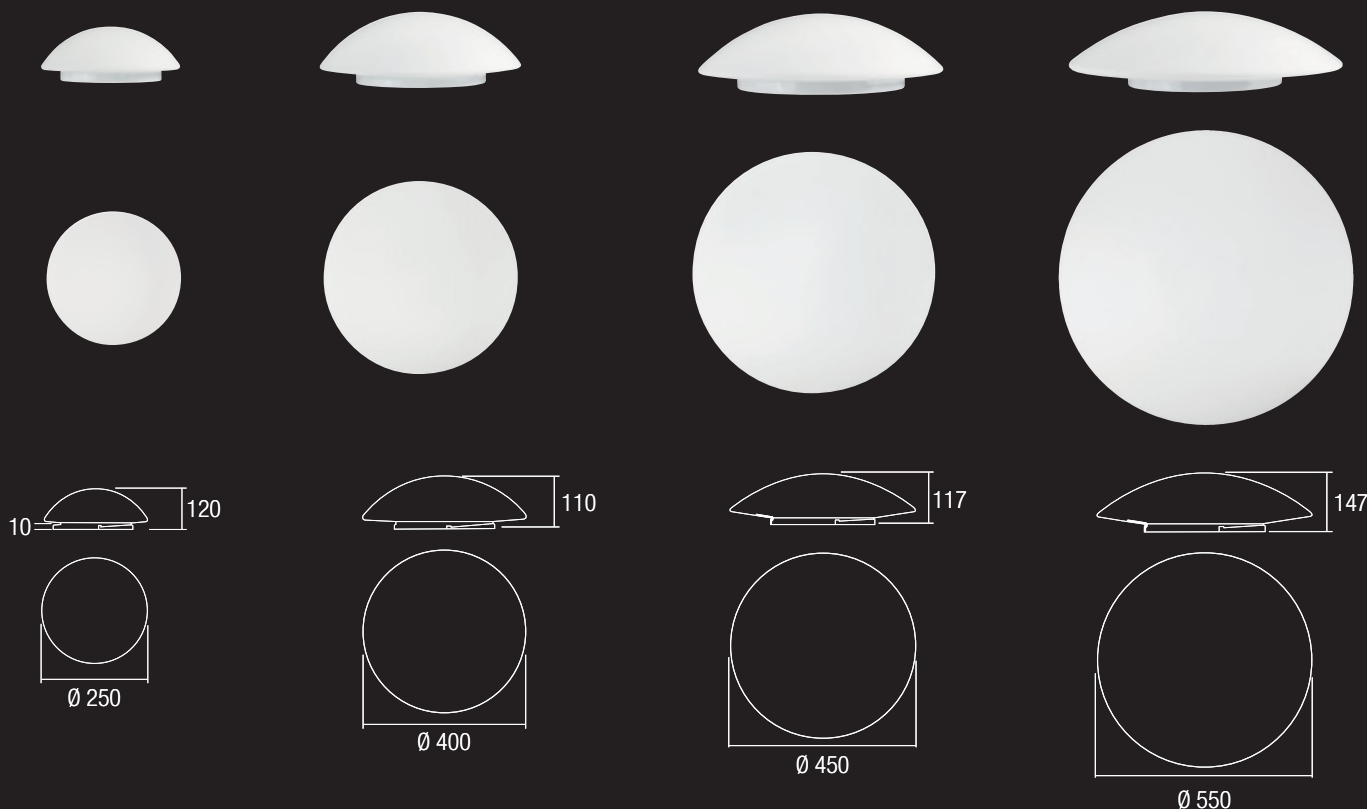

ARIETE 250 - S

B PLPOL250BCS

O Diffusore vetro opale
Diffusor opal glass

Sorgente
Source



2X
E27

CE IK07 IP20

220-240V 50/60Hz

ARIETE 355 - S

B PLLOW400BCS

O Diffusore vetro opale
Diffusor opal glass

Sorgente
Source



2X
E27

CE IK07 IP20

220-240V 50/60Hz

ARIETE 450 - S

B D63614

O Diffusore vetro opale
Diffusor opal glass

Sorgente
Source



2X
E27

CE IK07 IP20

220-240V 50/60Hz

ARIETE 550 - S

B PLLOW550BCS

O Diffusore vetro opale
Diffusor opal glass

Sorgente
Source



3X
E27

CE IK07 IP20

220-240V 50/60Hz



Sovraspecchio LED IP54

Over mirror lamps



Appliche in alluminio verniciato bianco o argento con schermo in policarbonato opale, IP54 con illuminazione a LED integrata 3CCT con possibilità di scelta tra tre diverse temperature di colore, bianco caldo, bianco neutro o bianco freddo, idonea per applicazioni in zone umide, utilizzo ideale come lampada sopra-specchio in bagno oppure per illuminare quadri.

Aluminium wall lamp painted white or silver plated with opal polycarbonate screen, IP54 with integrated LED illumination 3CCT with possibility of choice of three different color temperatures, warm white, neutral white or cool white, suitable for applications in humid areas, ideal for use as a light above the bathroom mirror or to light up pictures.

3 in 1

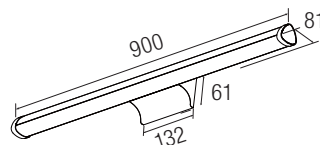
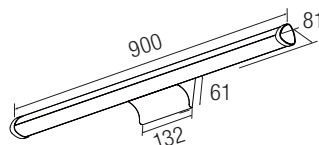
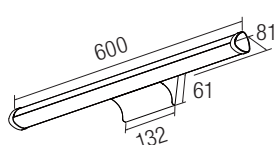
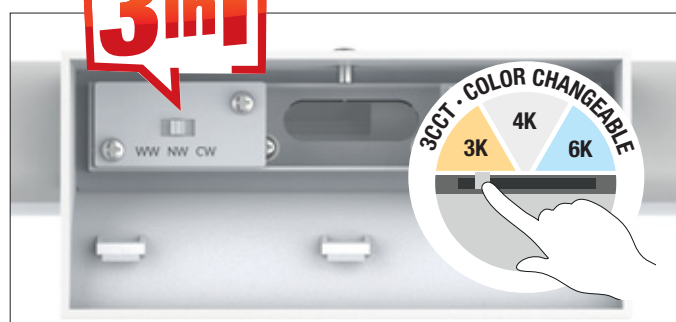

3000K - warm light



4000K - neutral light



6000K - cold light

Sovraspecchio 10W



Color Diffusor
 Bianco White PC Bianco White PC

Code

R-600B10W

Sorgente Source **LED**

Potenza Total power 10W

Temperatura di colore Color temperature 3CCT

	K	Lm
Flusso luminoso Lighting output	3000	1148
	4000	1180
	6000	1143

Angolo fascio luminoso Beam angle 110°



110-240V 50/60Hz

Sovraspecchio 15W



Color Diffusor
 Bianco White PC Bianco White PC

Code

R-900B-15W

Sorgente Source **LED**

Potenza Total power 15W

Temperatura di colore Color temperature 3CCT

	K	Lm
Flusso luminoso Lighting output	3000	1800
	4000	1842
	6000	1790

Angolo fascio luminoso Beam angle 110°



110-240V

Sovraspecchio 15W



Color Diffusor
 Argento Silver PC Bianco White PC

Code

R-900S-15W

Sorgente Source **LED**

Potenza Total power 15W

Temperatura di colore Color temperature 3CCT

	K	Lm
Flusso luminoso Lighting output	3000	1800
	4000	1842
	6000	1790

Angolo fascio luminoso Beam angle 110°



110-240V 50/60Hz

Specchio LED

Mirror lamps



Serie di specchi con lampada a LED incorporata in IP44, retroilluminati con banda sabbiata, accensione e spegnimento tramite pulsante sensoriale a sfioro posto sulla parte frontale dello specchio. Idonea per applicazioni in zone umide.

Corredato di supporti per il fissaggio, alimentatore posizionato all'interno della struttura e sorgente LED.

Series of mirrors with built-in IP44 LED lamp, backlit with sandblasted band, switching on and off by means of a sensory touch button on the front mirror doors. Suitable for applications in wet areas.

Equipped with supports for fixing, power supply positioned inside the structure and LED source.

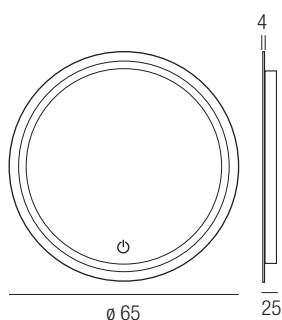
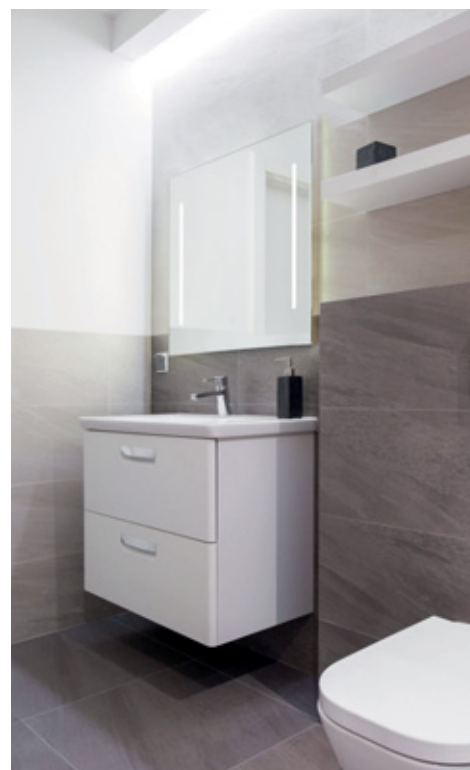

Specchio LED ø 65

Color	Diffusor
Specchio Mirror	Vetro satinato satin Glass

Cod.	M600	3000K
Sorgente Source		
Potenza Total power	15W	
Temperatura di colore Color temperature	3000K	
Flusso luminoso Lighting output	800Lm	
CELL		
220-240V 50/60Hz		

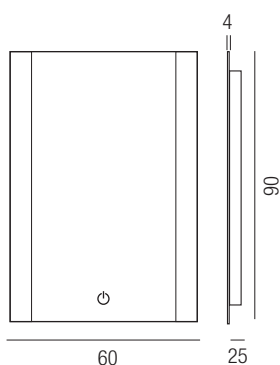

Specchio LED Verticale

Color	Diffusor
Specchio Mirror	Vetro satinato satin Glass

Cod.	M401	3000K
Sorgente Source		
Potenza Total power	15W	
Temperatura di colore Color temperature	3000K	
Flusso luminoso Lighting output	800Lm	
CELL		
220-240V 50/60Hz		

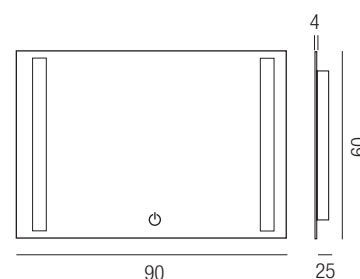

Specchio LED Orizzontale

Color	Diffusor
Specchio Mirror	Vetro satinato satin Glass

Cod.	M406	3000K
Sorgente Source		
Potenza Total power	15W	
Temperatura di colore Color temperature	3000K	
Flusso luminoso Lighting output	800Lm	
CELL		
220-240V 50/60Hz		

Buddleja T, Gerbera F Nandina F, Lavanda T



Non incluso
Not included

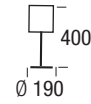

Buddleja T

Color	Diffusor	Code
Cromo Chrome	Bianco White	R-SD9456TCH
Rame Copper	Bianco White	R-SD9456TCOPP

Sorgente
Source **1X E27**



Gerbera F

Color	Diffusor
Nero Black	Opale Opal

Code
R-9264FBK
Sorgente
Source **4X E27**

Potenza
Total power max60W

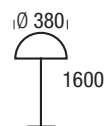
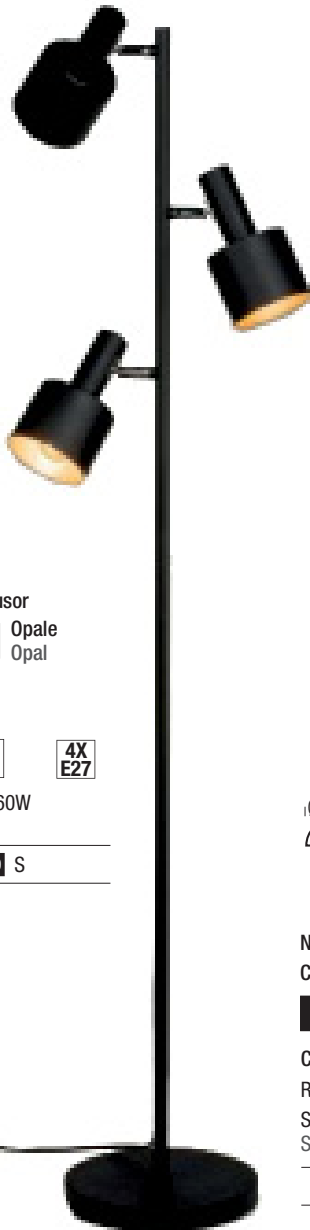

Nandina F

Color	Diffusor
Nero Black	Nero Black

Code
R-9474F
Sorgente
Source **3X E14**

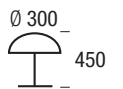

lavanda T

Color	Diffusor	Code
Bianco White	Bianco White	R-9305TWH
Nero Black	Nero Black	R-9305TBK

Sorgente
Source **2X E27**



Smart LED



LED
inside

Smart Led, corpo in alluminio, ABS.

- Porta USB per ricaricare i telefoni cellulari
- Interruttore tattile con funzione dimmer
- temperatura colore 4000K

Smart Led, body in aluminium, ABS.

- USB port to charge mobile phones
- Touch switch with dimming function
- colour temperature 4000K



Smart LED

Color **Code**
 Nero
 Black 8358

Sorgente 
 Source
Potenza 8W
 Total power

Temperatura di colore 3000K/6000K
 Color temperature

Flusso luminoso 400Lm
 Lighting output

    CELL

220-240V 50/60Hz DRIVER INCLUDED

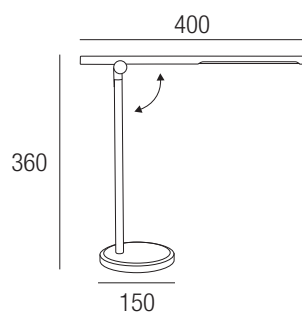

Serie LED Battery

*Senza fili, la porti...
..ovunque vuoi tu!*

**Accessorio a richiesta:
adattatore USB a 10 porte**
**Accessory on request:
10 port USB adapter**

Input: AC 100-240V
Output: 50/60Hz DC 5V 8A (max.)
Cable lenght: 120cm
Cod. USB10P



Portatile non necessita di prese di corrente grazie alla batteria ricaricabile può essere messa ovunque tu decida, con luce soft per momenti rilassanti, ottime per ambienti all'aperto, terrazzi o giardini, grazie all'alto grado IP.

Portable and rechargeable, it can be placed wherever you decide, with soft light for relaxing moments, excellent for outdoor environments, terraces or gardens thanks to the high IP rating.

- Portatile e ricaricabile
- 1 metro di cavo USB
- Dimmerabile
- 7 ore di luce senza fili
- Ideale per indoor e outdoor
- Luce calda e soft
- *Portable and rechargeable*
- *1 meter of USB cable*
- *Dimmable*
- *7 hours of wireless light*
- *Ideal for indoor and outdoor*
- *Warm and soft light*



	LED Po IP54	
	Color	Code
	Bianco White	PO-W-3W
	Nero Black	PO-BK-3W
	Grigio Grey	PO-GR-3W
Sorgente Source		LED
Potenza Total power		3W
Temperatura di colore Color temperature		3000K
Flusso luminoso Lighting output		136Lm

IK07 IP54 CELL

Batteria ioni di litio - Lithium-ion battery

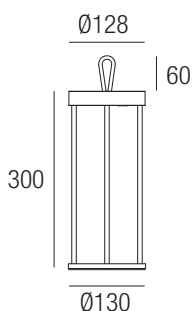

incluso
included

Gancio con cavo 60cm
Hook with cable 60cm

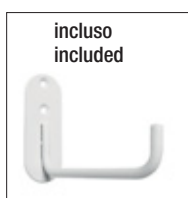

incluso
included

Staffa a parete
Wall bracket

LED Tevere lanterna

Color	Code
<input type="checkbox"/> Bianco White	TEVERE-W-3W

Sorgente Source	LED
Potenza Total power	3W
Temperatura di colore Color temperature	3000K
Flusso luminoso Lighting output	143Lm



Batteria ioni di litio - Lithium-ion battery

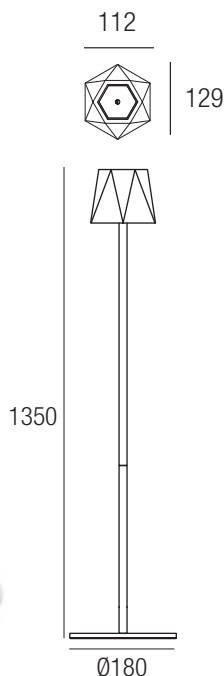

LED Reno Piantana

Color	Code
<input type="checkbox"/> Bianco White	RENO-P-W-3W

Sorgente Source	LED
Potenza Total power	3W
Temperatura di colore Color temperature	3000K
Flusso luminoso Lighting output	136Lm



Batteria ioni di litio - Lithium-ion battery

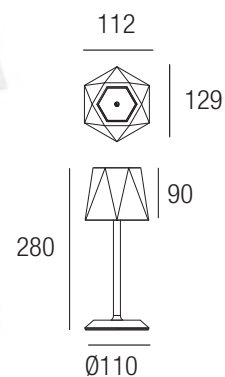

LED Reno tavolo

Color	Code
<input type="checkbox"/> Bianco White	RENO-W-3W

Sorgente Source	LED
Potenza Total power	3W
Temperatura di colore Color temperature	3000K
Flusso luminoso Lighting output	136Lm



Batteria ioni di litio - Lithium-ion battery

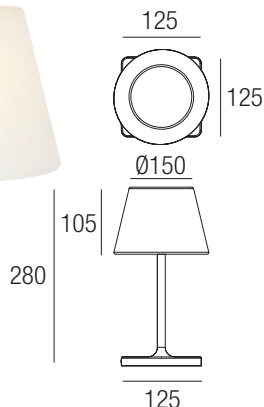

LED Piave

Color	Code
<input type="checkbox"/> Bianco White	PIAVE-W-3W

Sorgente Source	LED
Potenza Total power	2W
Temperatura di colore Color temperature	3000K
Flusso luminoso Lighting output	170Lm



A batteria - Battery

